

PART No. 1486B24

Data subject to change without notice

Isometric drawing Not to Scale

Gross Automation (877) 268-3700 · www.hammondenclosuresales.com · sales@grossautomation.com

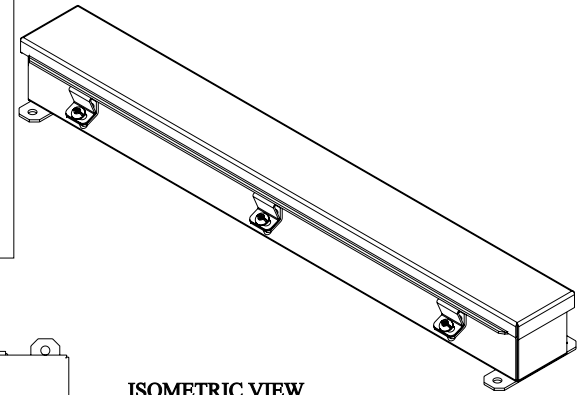

ISOMETRIC VIEW

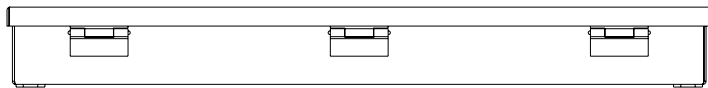

BACK VIEW

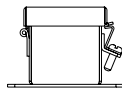

SIDE VIEW

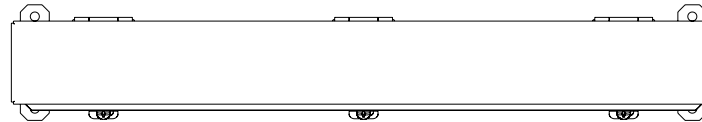

TOP VIEW

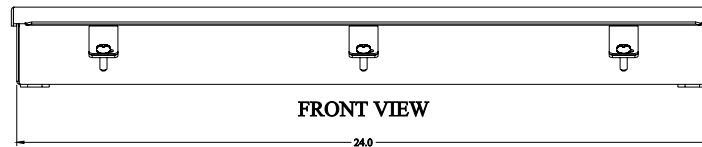

FRONT VIEW

240

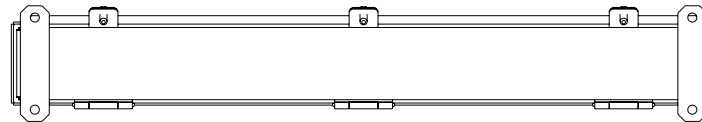

BOTTOM VIEW

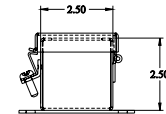

SIDE VIEW

2.50

2.50