



# PART No. 1486B18



Data subject to change without notice

Isometric drawing Not to Scale

Gross Automation (877) 268-3700 · [www.hammondenclosuresales.com](http://www.hammondenclosuresales.com) · [sales@grossautomation.com](mailto:sales@grossautomation.com)

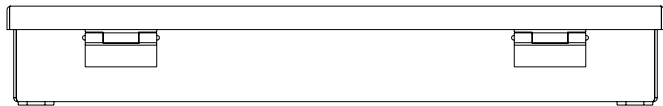
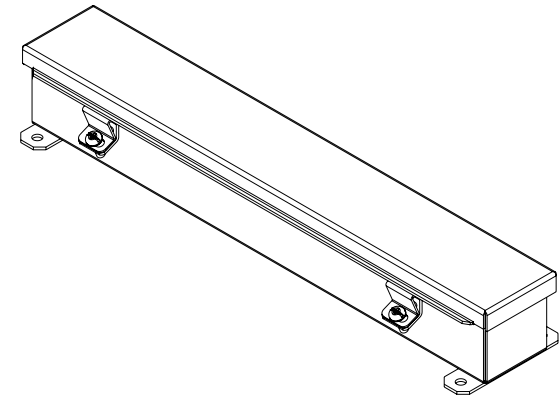

BACK VIEW

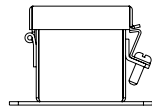

SIDE VIEW

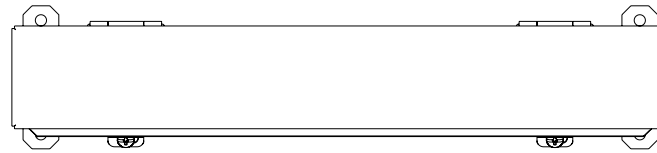

TOP VIEW

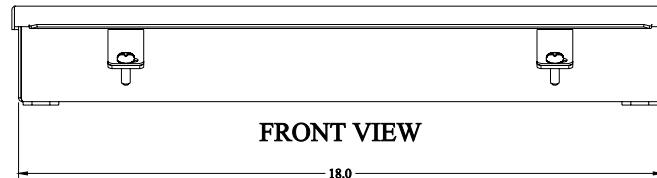

FRONT VIEW

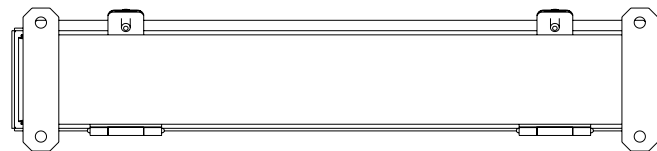

BOTTOM VIEW

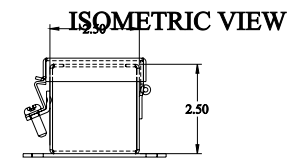

SIDE VIEW