

PART No. 1486B12

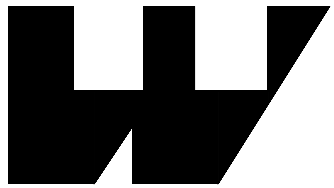

Data subject to change without notice

Isometric drawing Not to Scale

Gross Automation (877) 268-3700 · www.hammondenclosuresales.com · sales@grossautomation.com

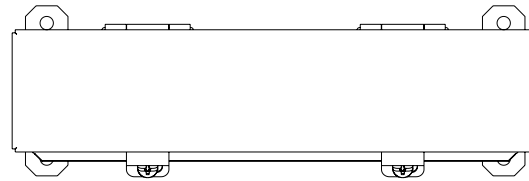
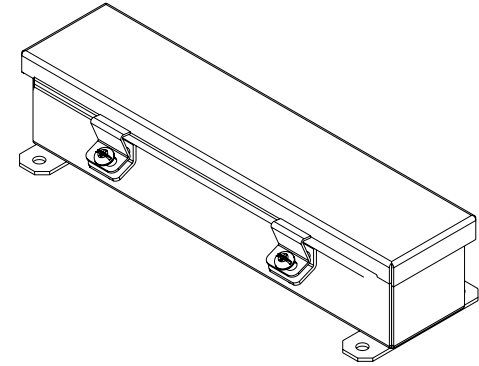

TOP VIEW

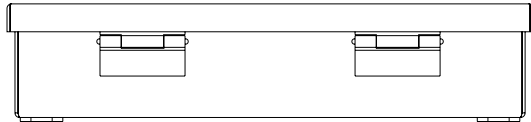

BACK VIEW

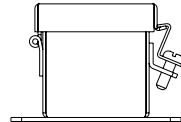

SIDE VIEW

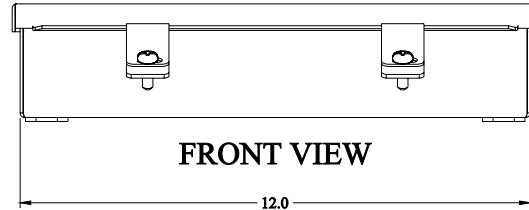

FRONT VIEW

12.0

ISOMETRIC VIEW

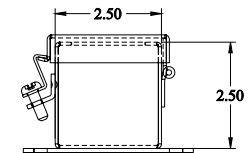

SIDE VIEW

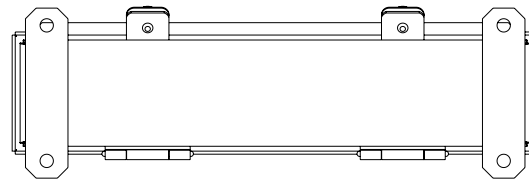

BOTTOM VIEW