

PART No. 1489P9

Data subject to change without notice
Isometric drawing Not to Scale

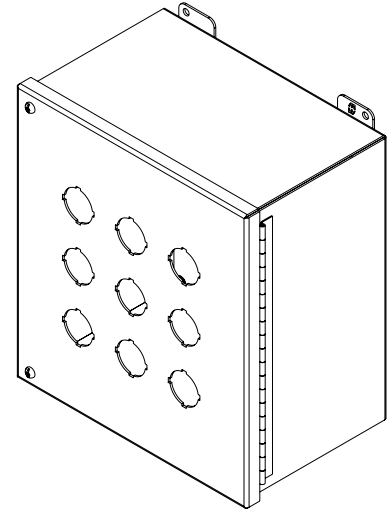
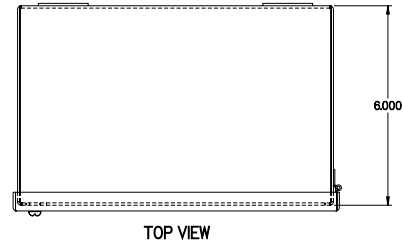

ISOMETRIC VIEW

Gross Automation (877) 268-3700 · www.hammondenclosuresales.com · sales@grossautomation.com

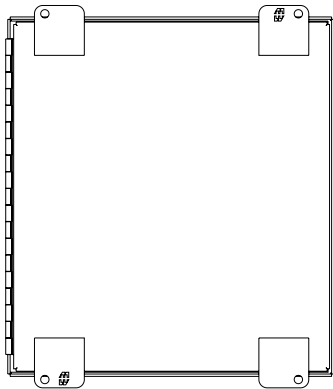
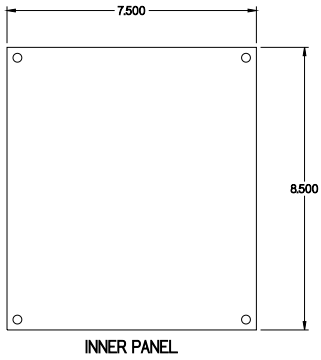

BACK VIEW

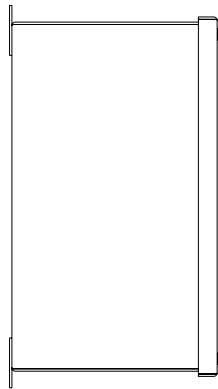

LEFT SIDE VIEW

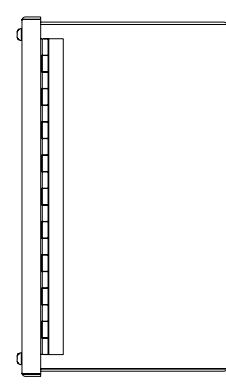
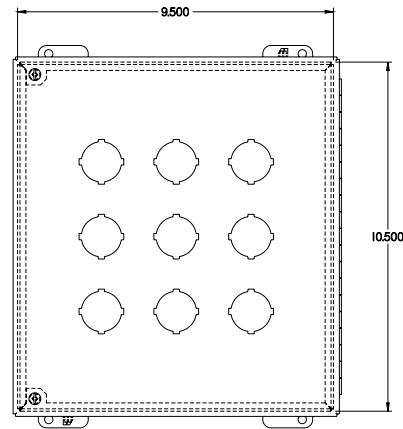

RIGHT SIDE VIEW



BOTTOM VIEW