

PART No. 1437MX

Data subject to change without notice
Isometric drawing Not to Scale

Gross Automation (877) 268-3700 · www.hammondenclosuresales.com · sales@grossautomation.com

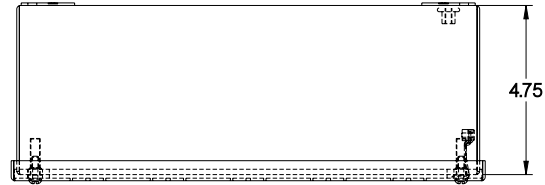

TOP VIEW

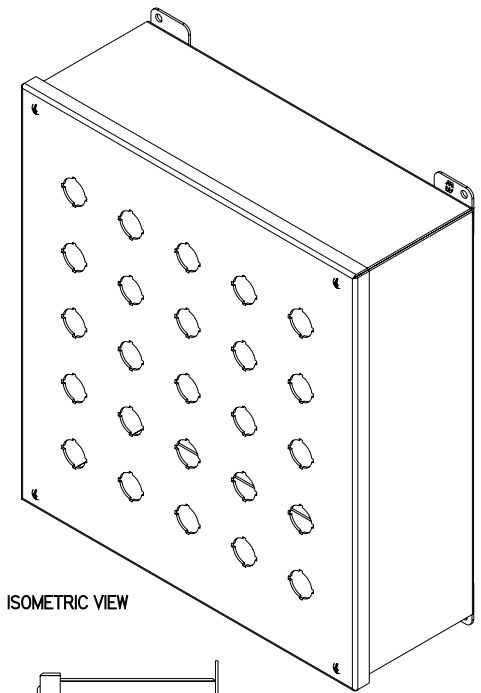

ISOMETRIC VIEW

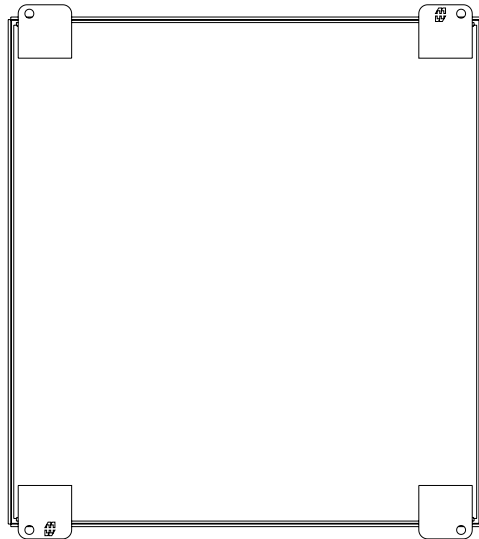

BACK VIEW

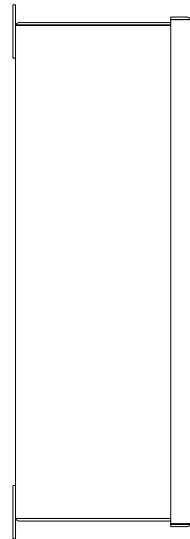

LEFT SIDE VIEW

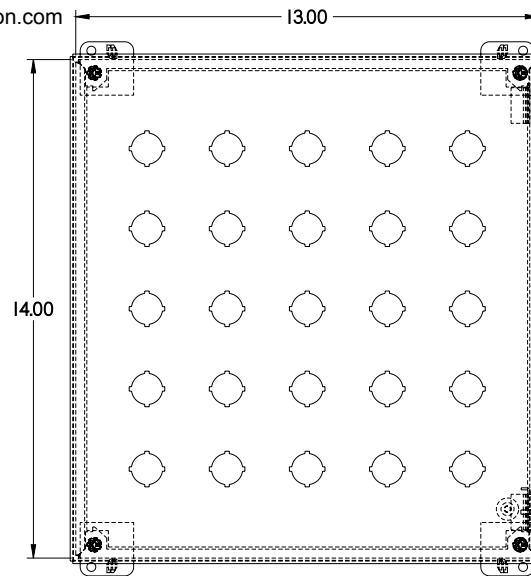

FRONT VIEW

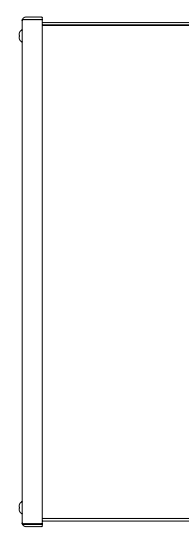

RIGHT SIDE VIEW

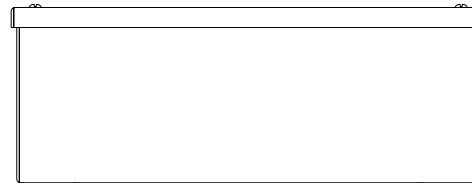

BOTTOM VIEW