

**PART No. 1437B**

Data subject to change without notice

Isometric drawing Not to Scale

Gross Automation (877) 268-3700 · [www.hammondenclosuresales.com](http://www.hammondenclosuresales.com) · [sales@grossautomation.com](mailto:sales@grossautomation.com)

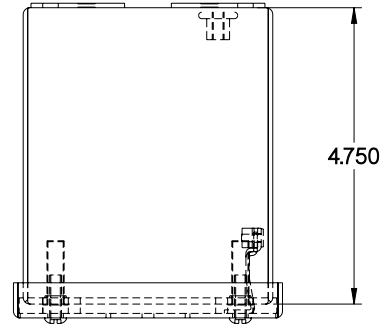

TOP VIEW

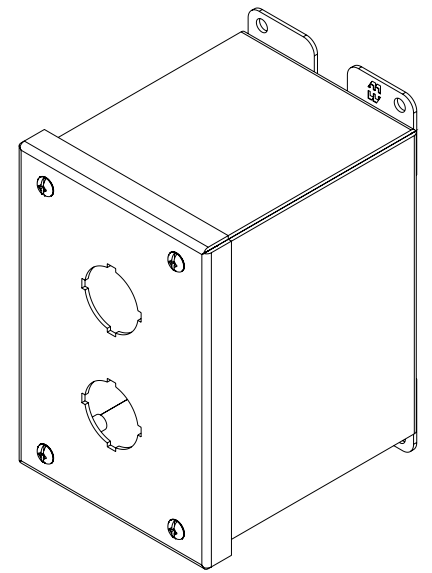

ISOMETRIC VIEW

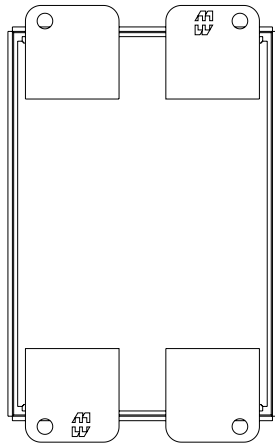

BACK VIEW

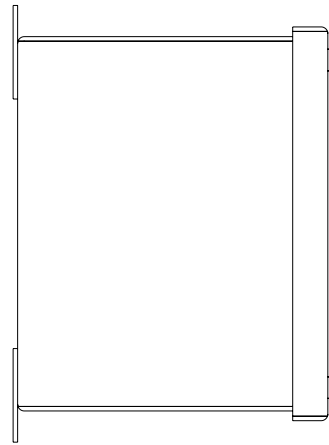

LEFT SIDE VIEW

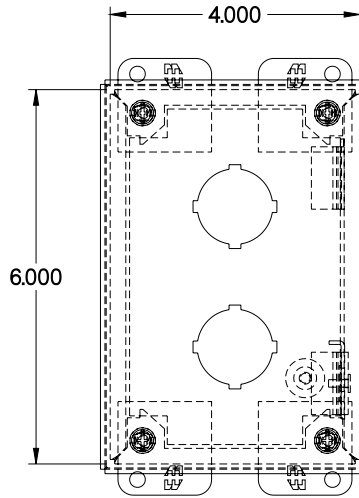

FRONT VIEW

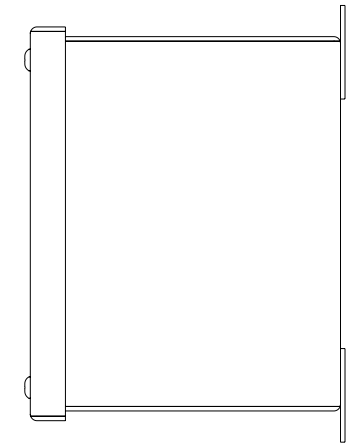

RIGHT SIDE VIEW

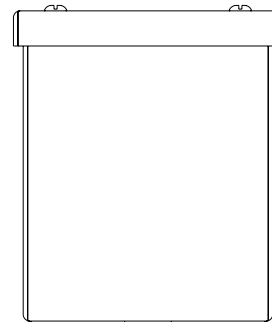

BOTTOM VIEW