

# PART No. 1418N4S8

Data subject to change without notice

Isometric drawing Not to Scale

Gross Automation (877) 268-3700 · [www.hammondenclosuresales.com](http://www.hammondenclosuresales.com) · [sales@grossautomation.com](mailto:sales@grossautomation.com)

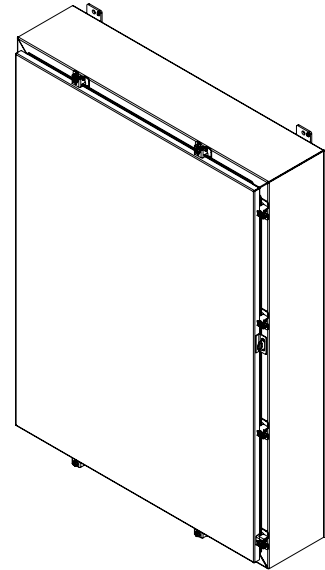

ISOMETRIC VIEW

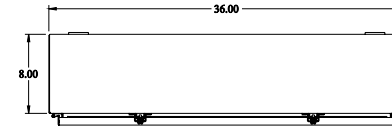

TOP VIEW

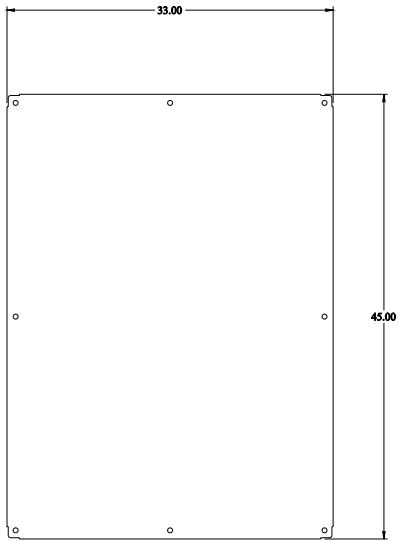

INNER PANEL

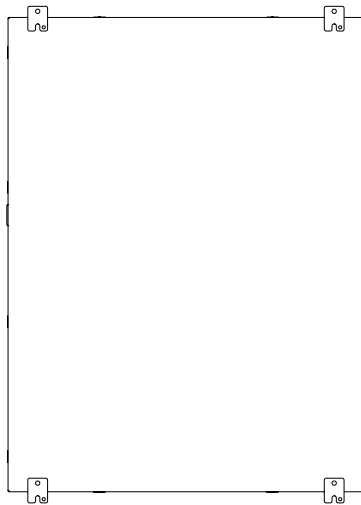

BACK VIEW

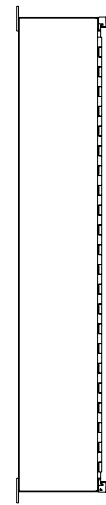

SIDE VIEW

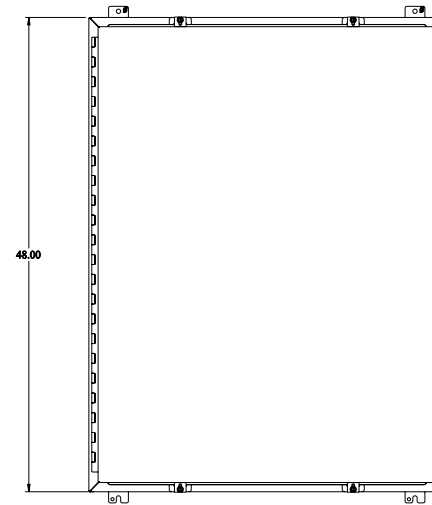

FRONT VIEW

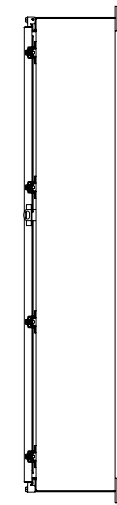

SIDE VIEW

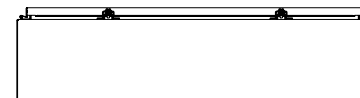

BOTTOM VIEW