

**PART No. 1418N4D6**

Data subject to change without notice

Isometric drawing Not to Scale

Gross Automation (877) 268-3700 · www.hammondenclosuresales.com · sales@grossautomation.com

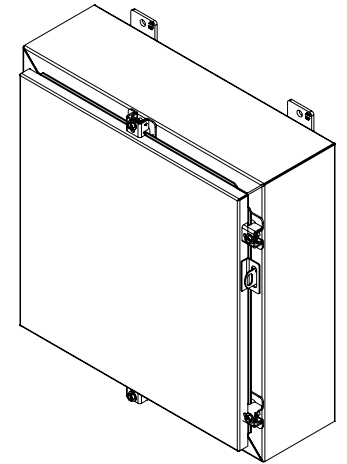

**ISOMETRIC VIEW**

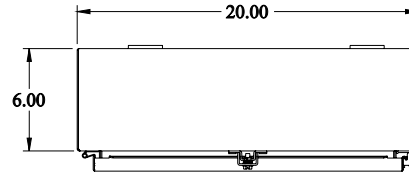

**TOP VIEW**

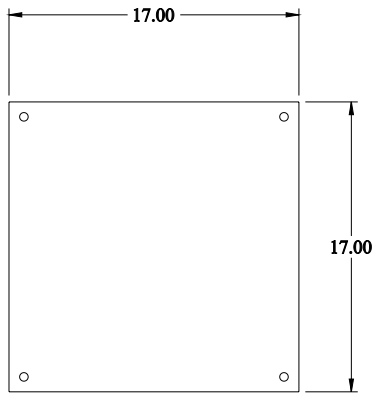

**INNER PANEL**

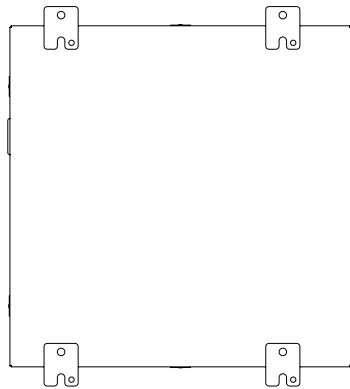

**BACK VIEW**

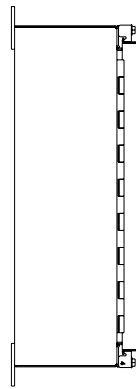

**SIDE VIEW**

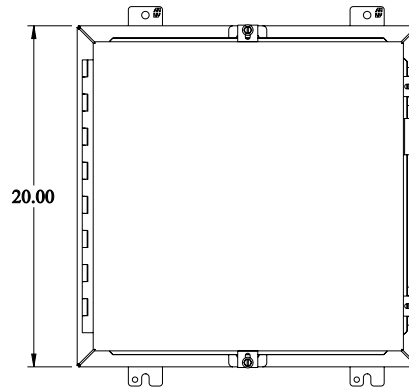

**FRONT VIEW**

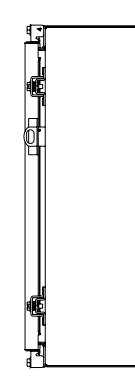

**SIDE VIEW**

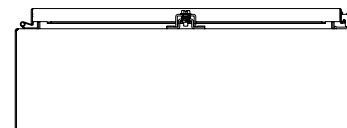

**BOTTOM VIEW**