

PART No. AP1620PP

for more information visit

www.hammfg.com

Data subject to change without notice

Isometric drawing Not to Scale

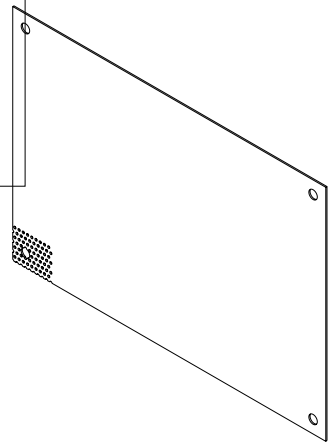

TOP VIEW

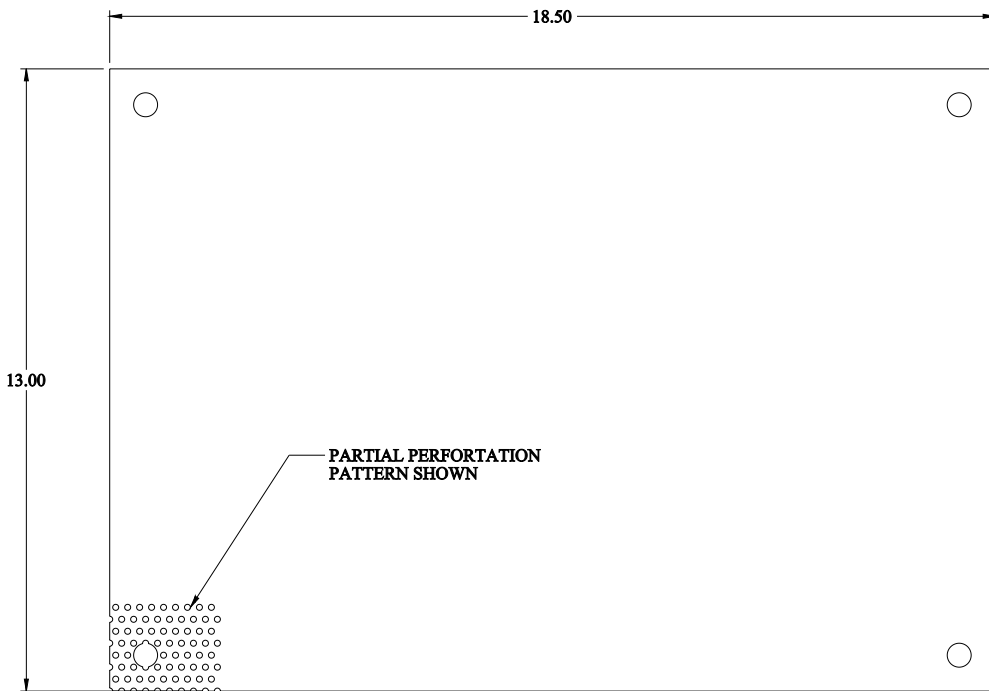

FRONT VIEW

SIDE VIEW

ISOMETRIC VIEW