

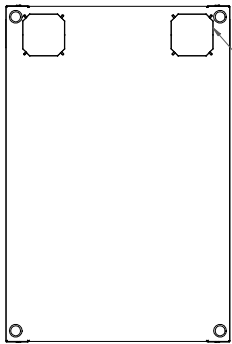

PART No. RCSC1904236
 for more information visit
www.hammfg.com
 Data subject to change without notice.
 Isometric drawing not to scale.
 Shipped knockdown for handling ease
 & protection.

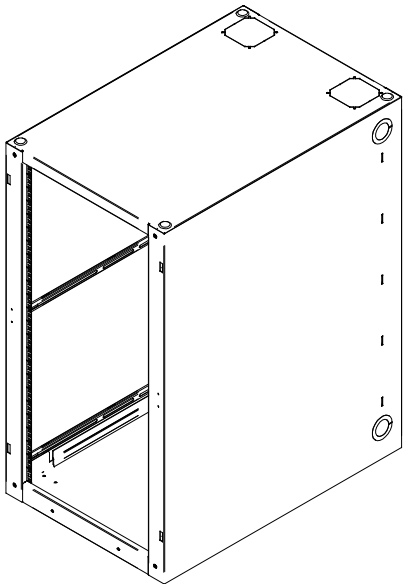

4" MUFFIN FAN
 CUTOUT OR CABLE
 PASS-THRU HOLE
 (KNOCK-OUT)

TOP VIEW

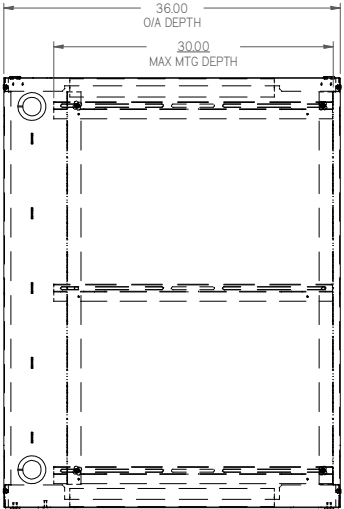

L.S. VIEW

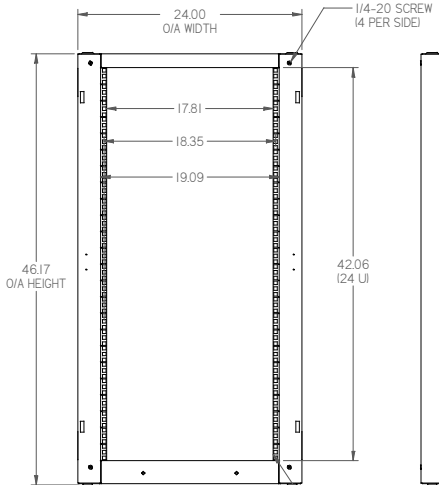

FRONT VIEW

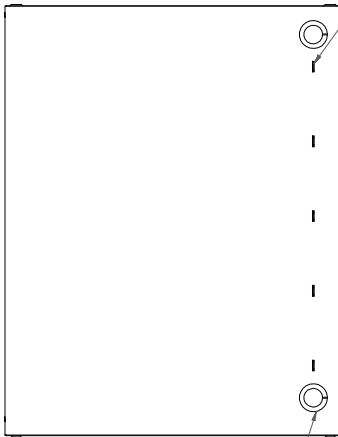

R.S. VIEW

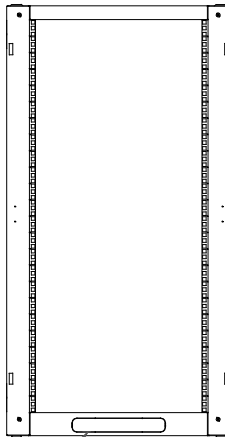

REAR VIEW

INCLUDES 2 PAIR OF
 ADJUSTABLE SQUARE
 HOLE PANEL RAILS.

2.00 X 3.00
 DOUBLE KNOCK-OUT
 (2 PER SIDE)

1.50 X 10.00
 GLAND OPENING
 (KNOCK-OUT)

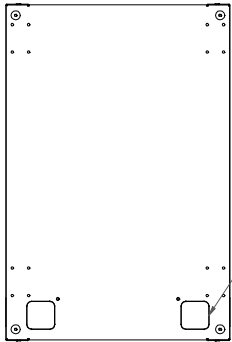

BOTTOM VIEW

3" X 3" CABLE
 PASS-THRU HOLE
 (KNOCK-OUT)