

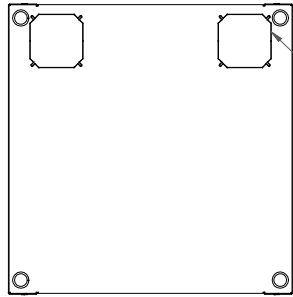

**PART No. RCSC1902124**  
 for more information visit  
[www.hamfmg.com](http://www.hamfmg.com)  
 Data subject to change without notice.  
 Isometric drawing not to scale.  
 Shipped knockdown for handling ease  
 & protection.



4" MUFFIN FAN  
 CUTOUT OR CABLE  
 PASS-THRU HOLE  
 (KNOCK-OUT)

TOP VIEW

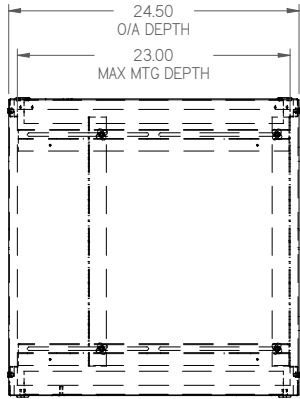
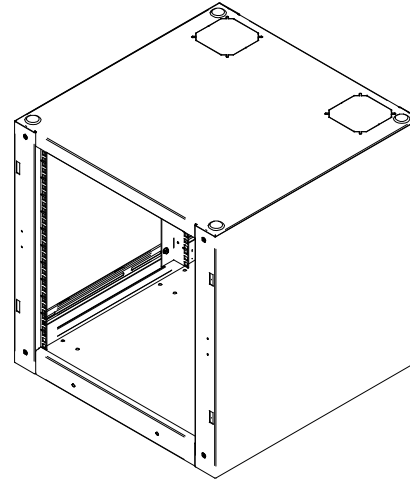

L.S. VIEW

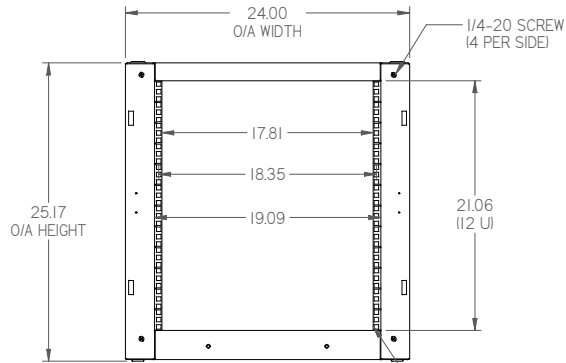

FRONT VIEW

INCLUDES 2 PAIR OF  
 ADJUSTABLE SQUARE  
 HOLE PANEL RAILS.

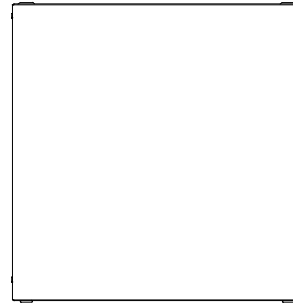

R.S. VIEW

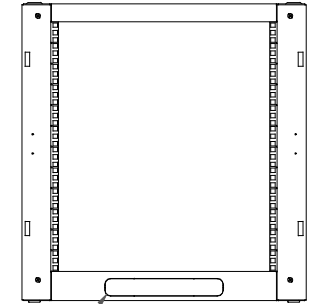

REAR VIEW

1.50 X 10.00  
 GLAND OPENING  
 (KNOCK-OUT)

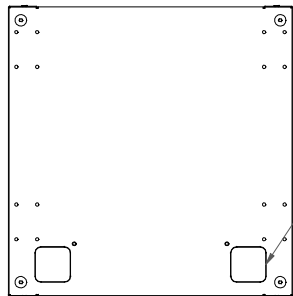

3" X 3" CABLE  
 PASS-THRU HOLE  
 (KNOCK-OUT)

BOTTOM VIEW