

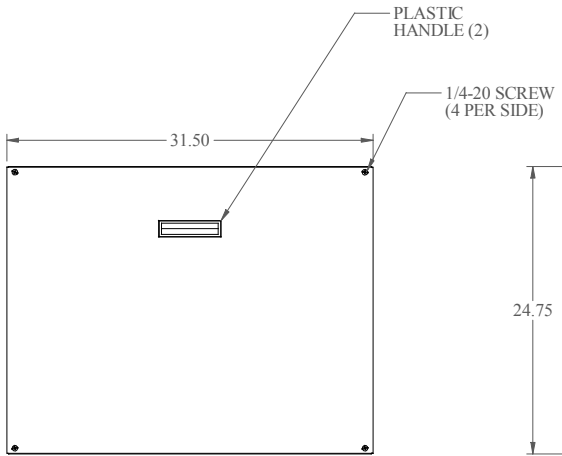

PART No. RCHS1902231
 for more information visit
www.hammfg.com
 Data subject to change without notice.
 Isometric drawing not to scale.
 Shipped knockdown for handling ease
 & protection.

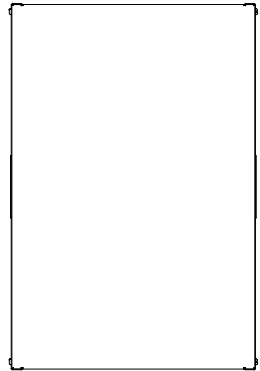

L.S. VIEW



TOP VIEW

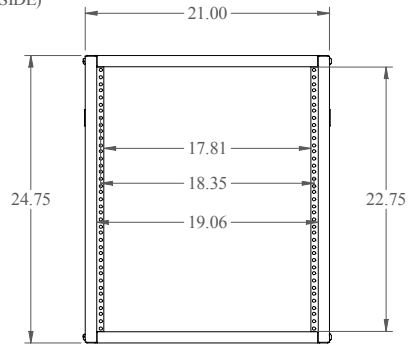

FRONT VIEW

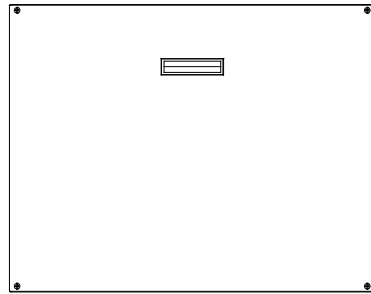
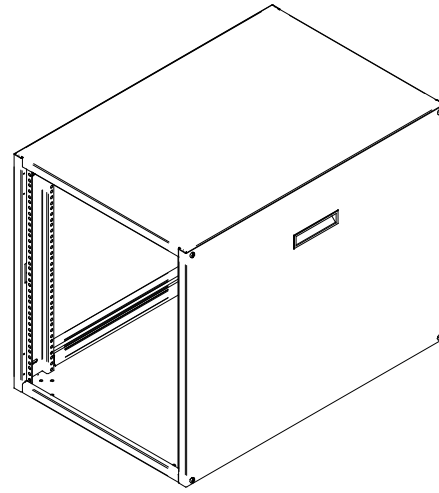

R.S. VIEW

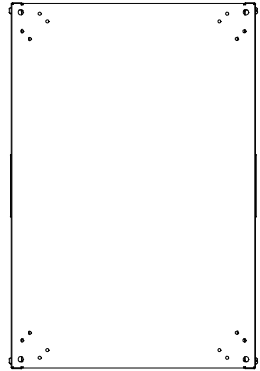

BOTTOM VIEW