

**PART No. EN4DSC20228SS**

Data subject to change without notice

Isometric drawing Not to Scale

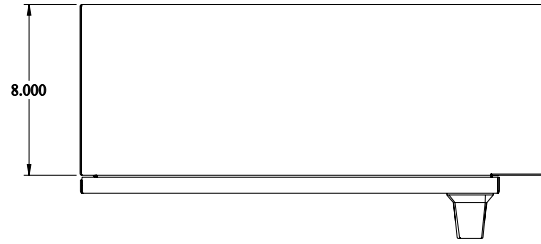

**TOP VIEW**

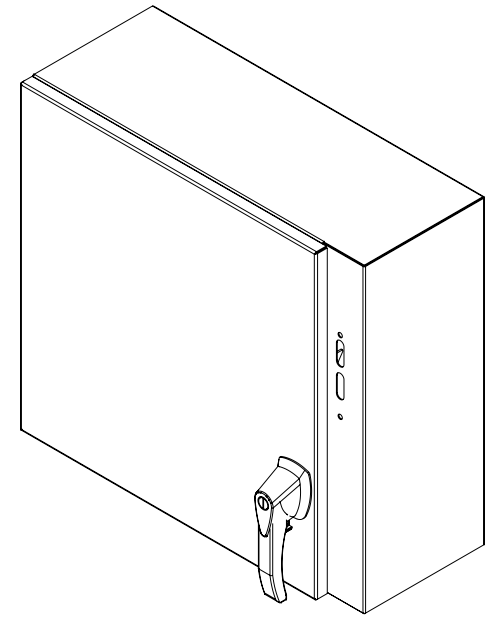

**ISOMETRIC VIEW**



**BACK VIEW**

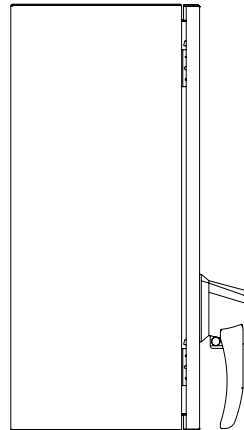

**LEFT SIDE VIEW**

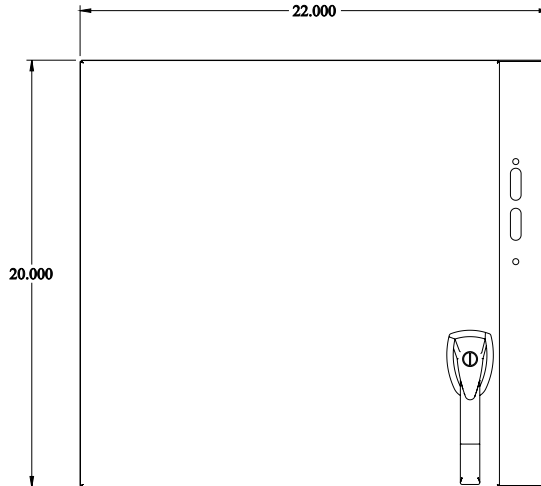

**FRONT VIEW**

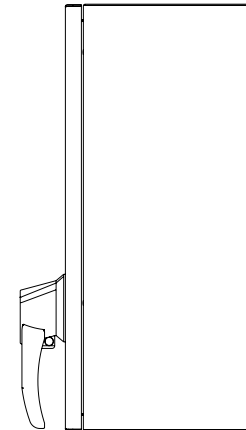

**RIGHT SIDE VIEW**



**BOTTOM VIEW**