

PART No. **EPGDH1624**

for more information visit

www.hammfg.com

Data subject to change without notice

Isometric drawing Not to Scale

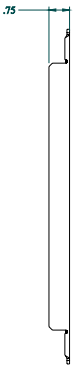

SIDE VIEW



FRONT VIEW

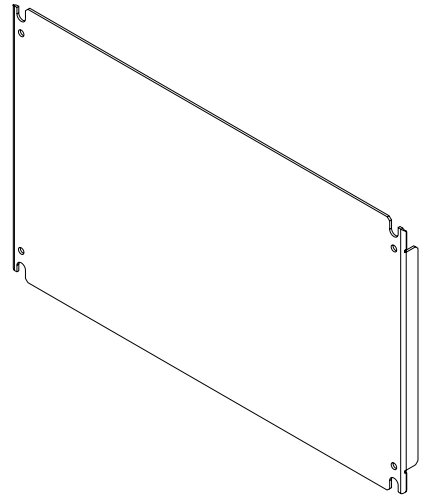

ISOMETRIC VIEW