

DATE	SYM.	DESCRIPTION	DR	CK	REL

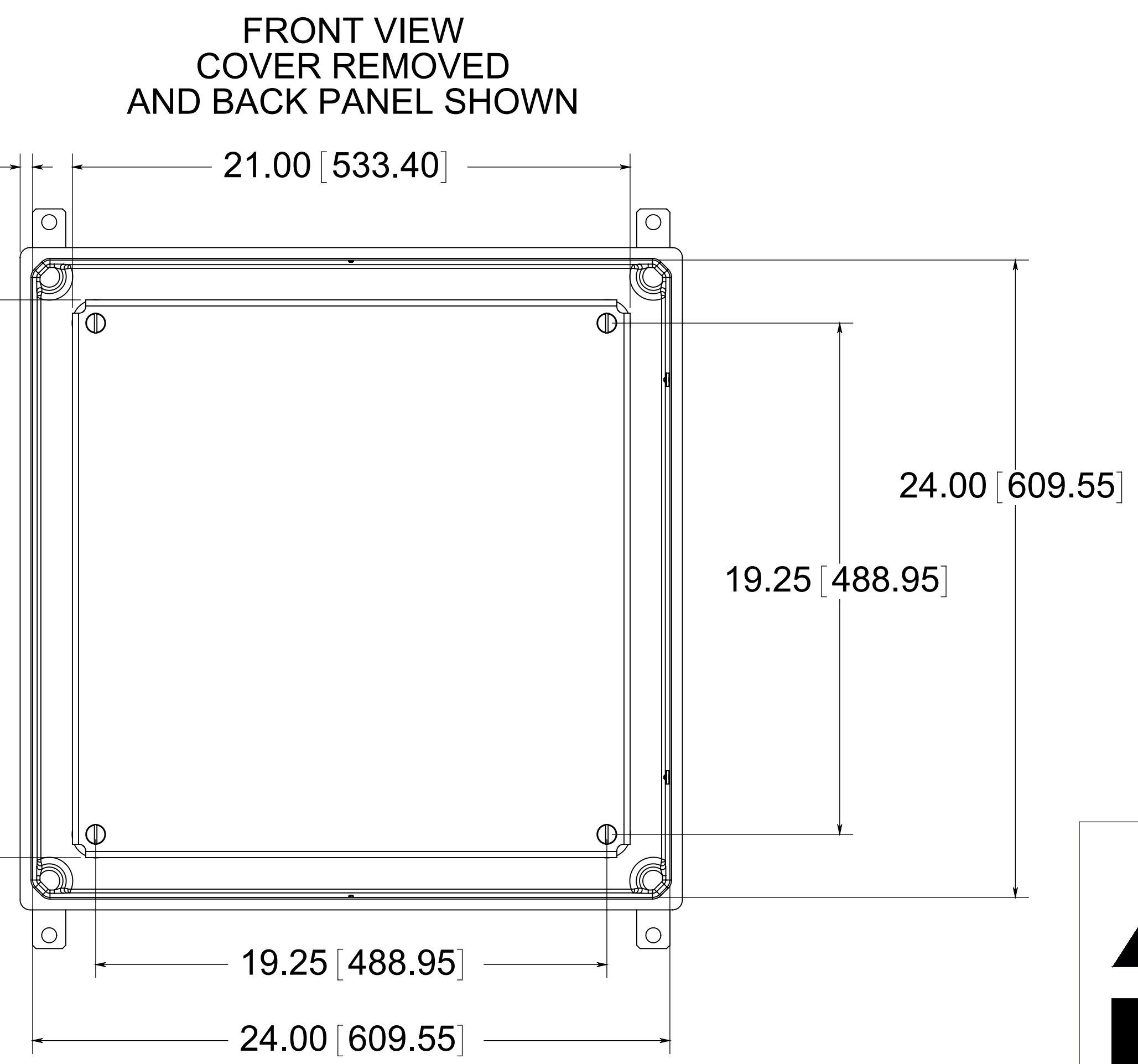
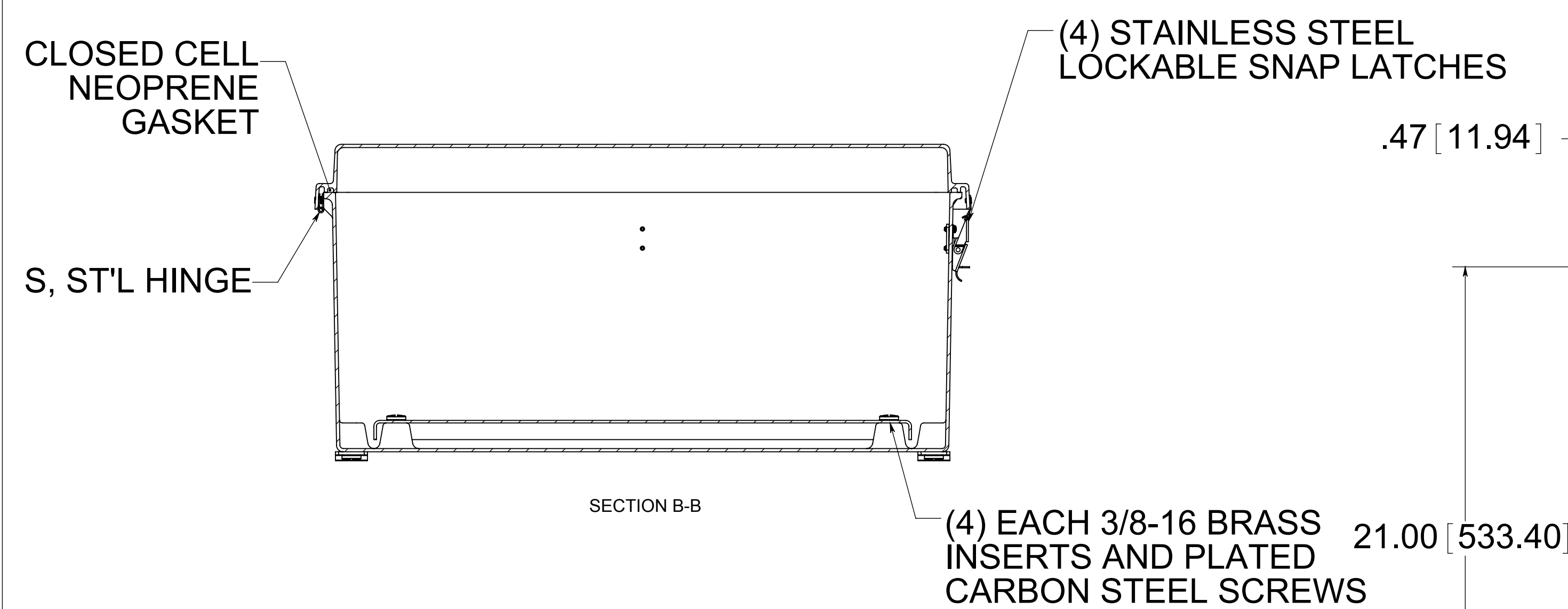
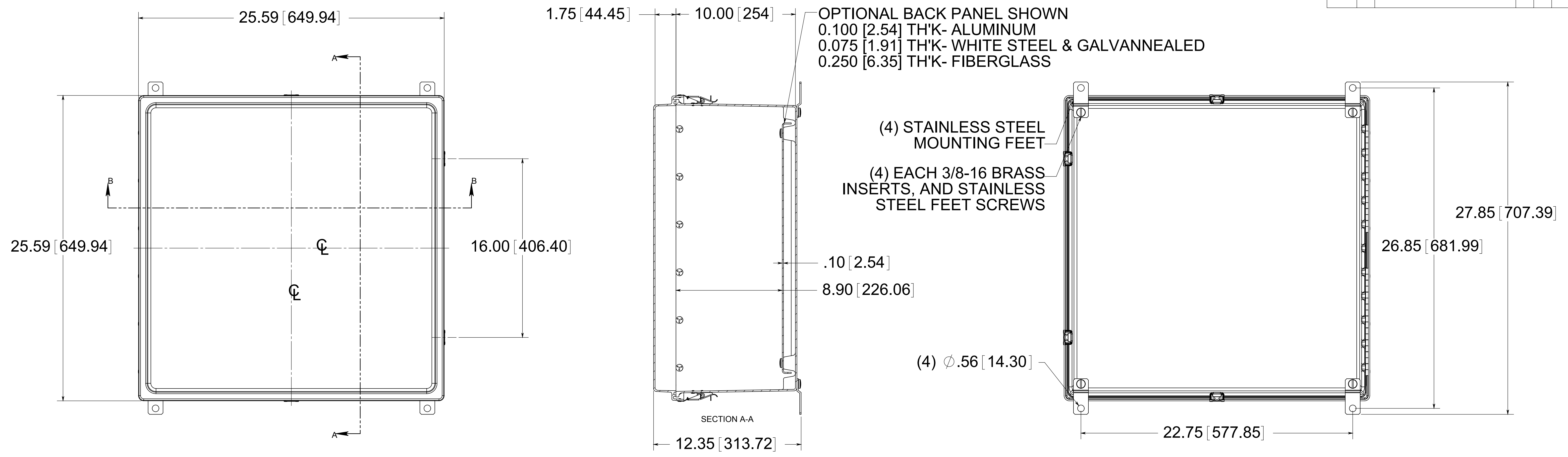

MATERIAL:
 BOX-COMPRESSION MOLDED FIBERGLASS REINFORCED POLYESTER
 COVER- COMPRESSION MOLDED FIBERGLASS REINFORCED POLYESTER
 WINDOW- POLYCARBONATE

PART No. PJ24240RL
 for more information visit
www.hammfg.com
 Data subject to change without notice
 Drawing Not to Scale