

DATE	SYM.	DESCRIPTION	DR	CK	REL

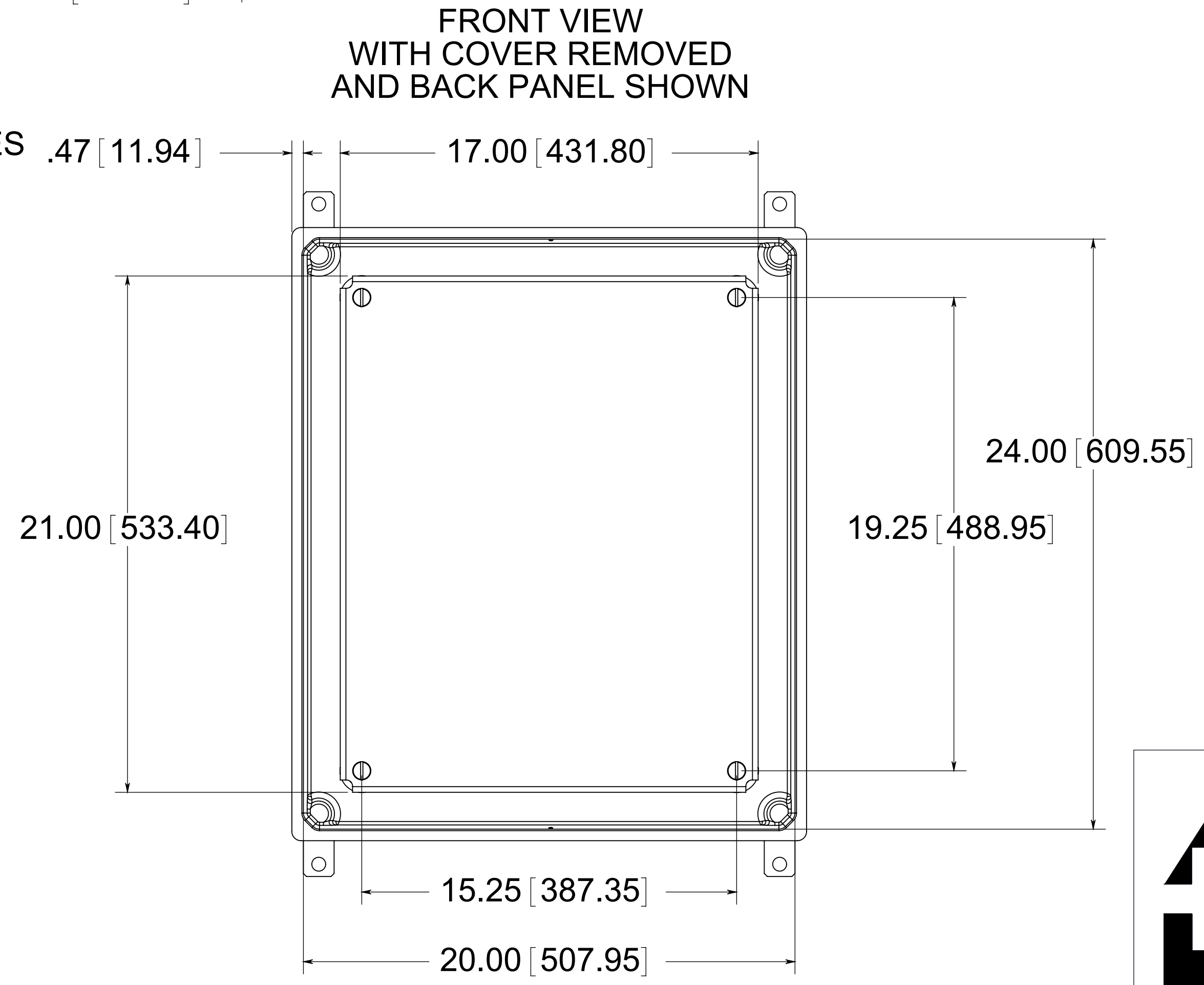
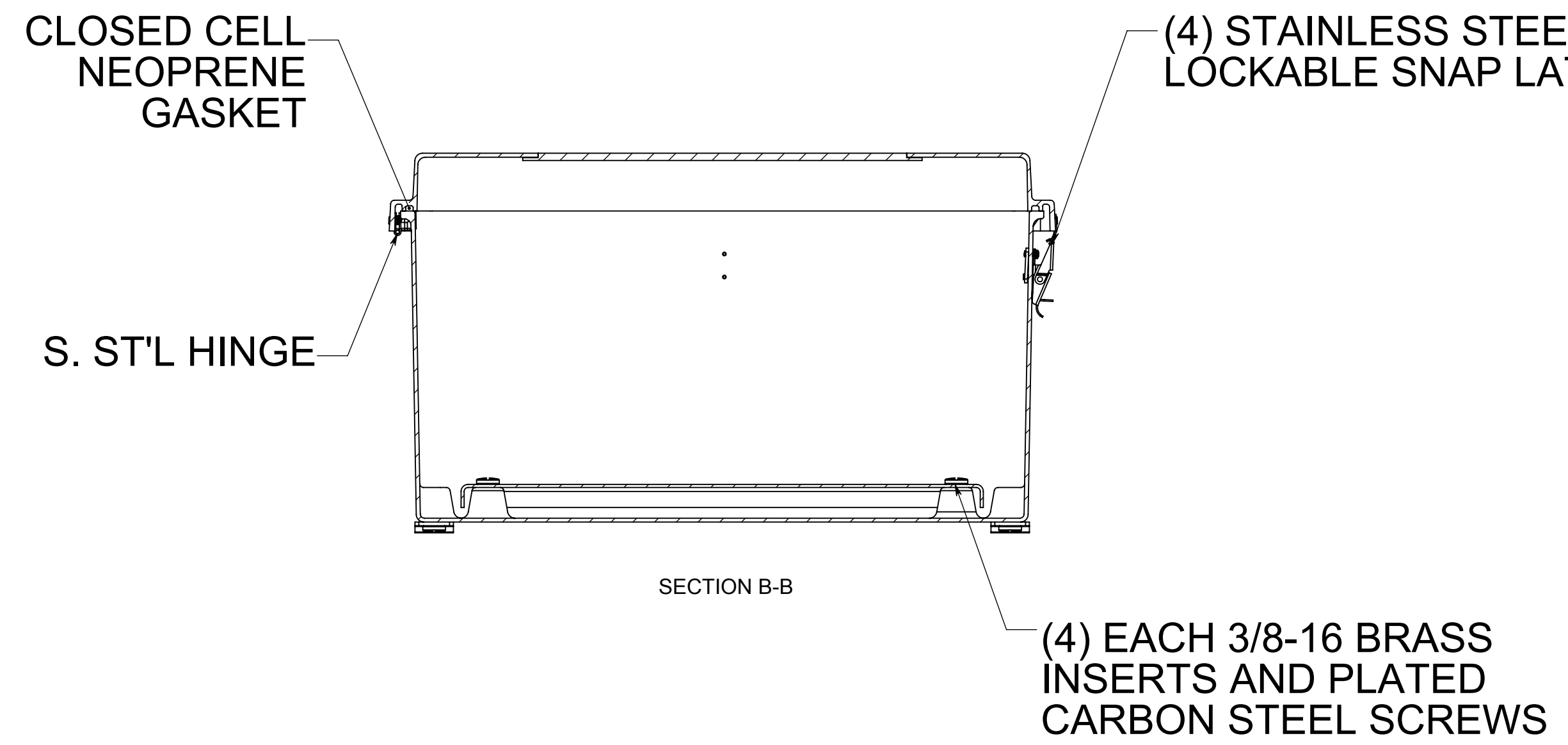
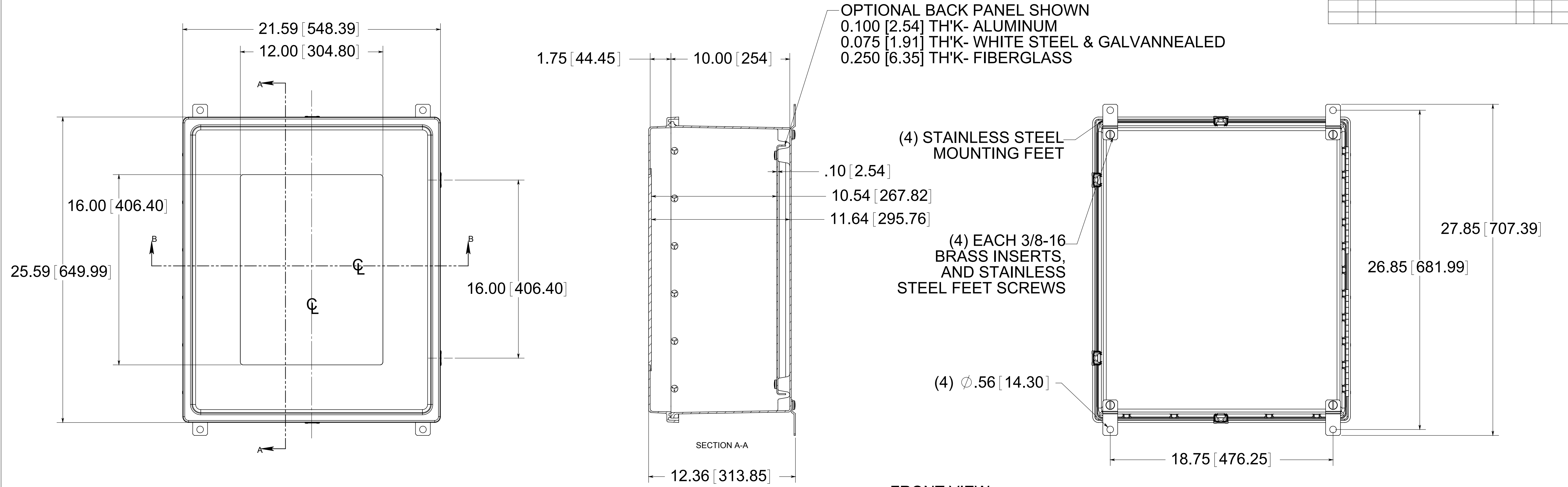

**MATERIAL:**  
 BOX- COMPRESSION MOLDED FIBERGLASS REINFORCED POLYESTER  
 COVER- COMPRESSION MOLDED FIBERGLASS REINFORCED POLYESTER  
 WINDOW- POLYCARBONATE

**PART No. PJ24200RLW**  
 for more information visit  
[www.hammfg.com](http://www.hammfg.com)  
 Data subject to change without notice  
 Drawing Not to Scale