

DATE	SYM.	DESCRIPTION	DR	CK	REL

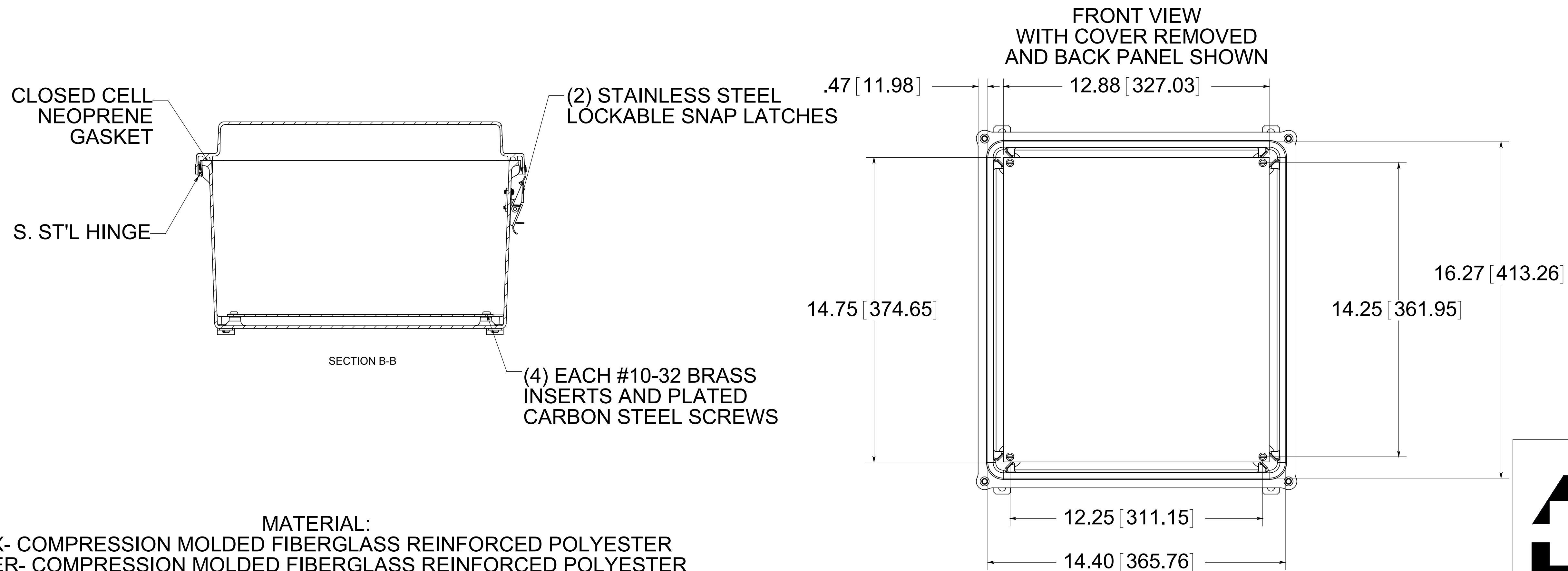

MATERIAL:
 BOX- COMPRESSION MOLDED FIBERGLASS REINFORCED POLYESTER
 COVER- COMPRESSION MOLDED FIBERGLASS REINFORCED POLYESTER
 WINDOWS- POLYCARBONATE

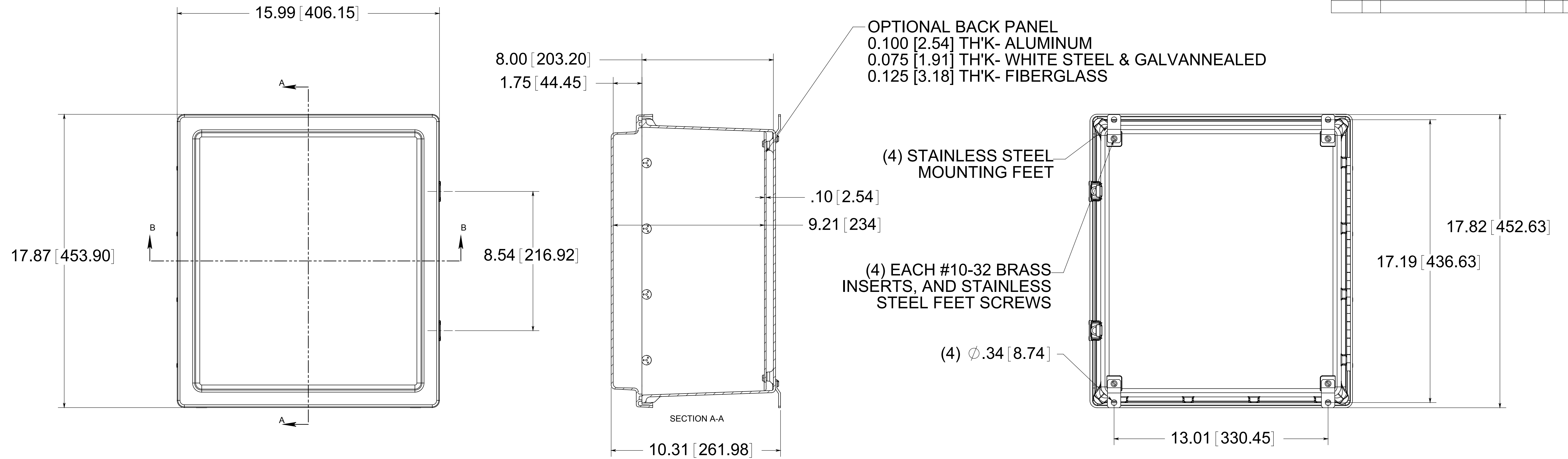
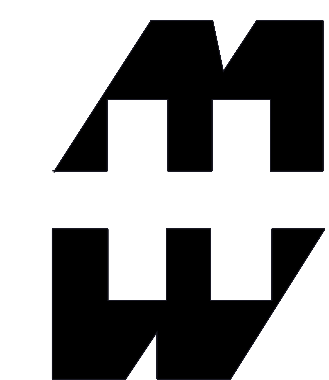

PART No. PJ1648RL
 for more information visit
www.hammfg.com
 Data subject to change without notice
 Drawing Not to Scale