

DATE	SYM.	DESCRIPTION	DR	CK	REL

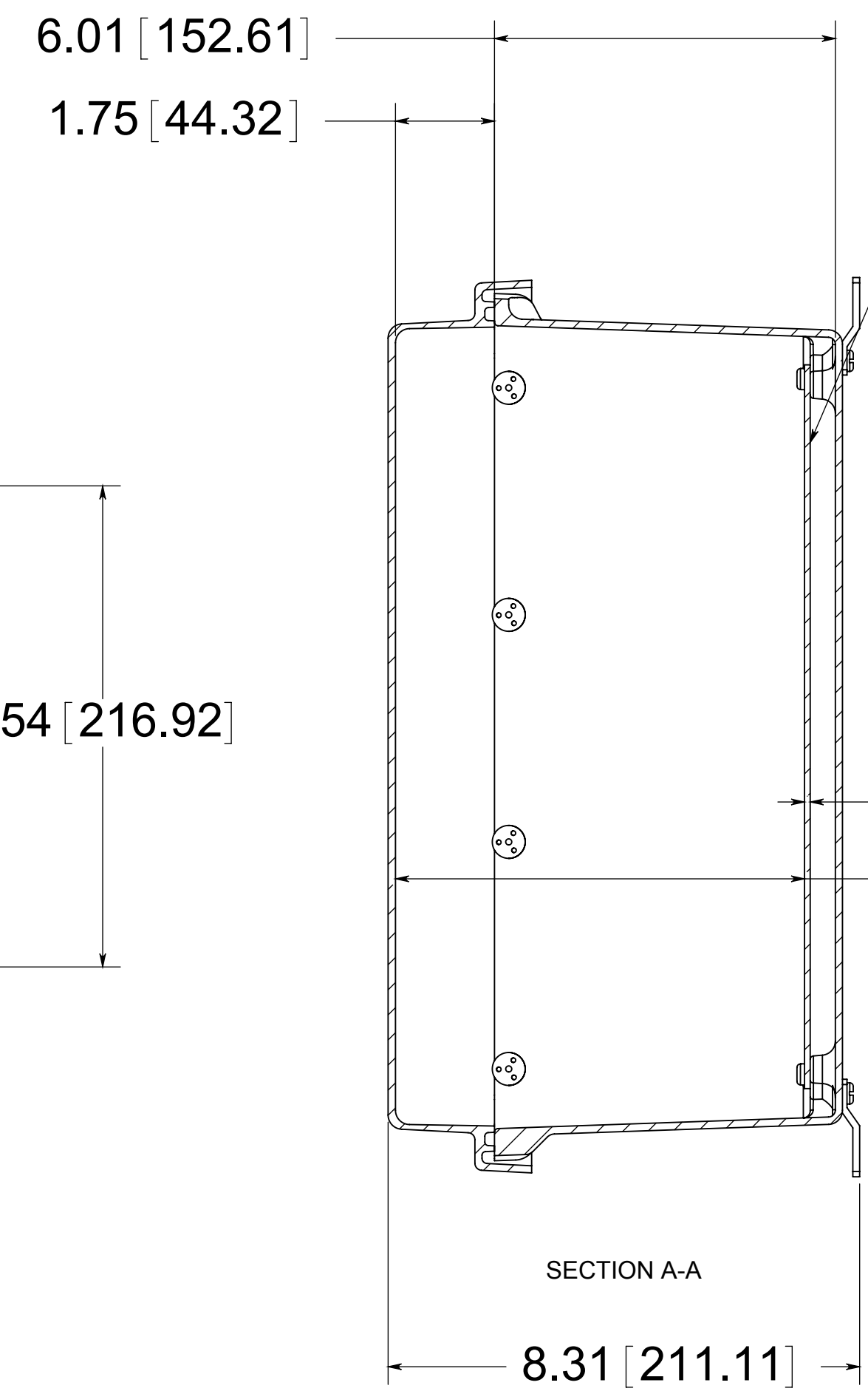
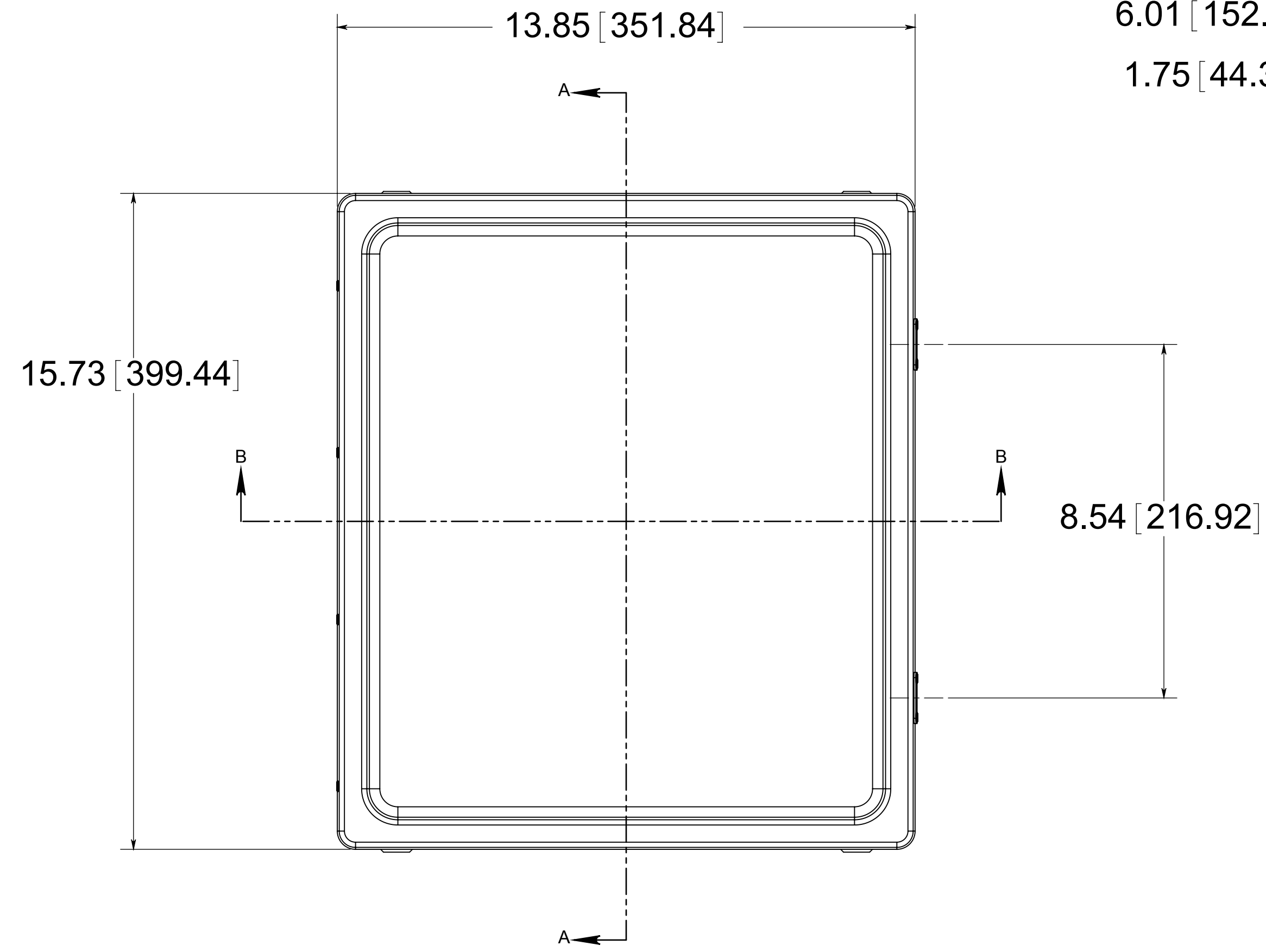

OPTIONAL BACK PANEL  
 0.100 [2.54] TH'K- ALUMINUM  
 0.075 [1.91] TH'K- WHITE STEEL & GALVANNEALED  
 0.125 [3.18] TH'K- FIBERGLASS

(4) STAINLESS STEEL MOUNTING FEET  
 (4) EACH #10-32 BRASS INSERTS, AND STAINLESS STEEL FEET SCREWS

(4)  $\phi$ .34 [8.74]

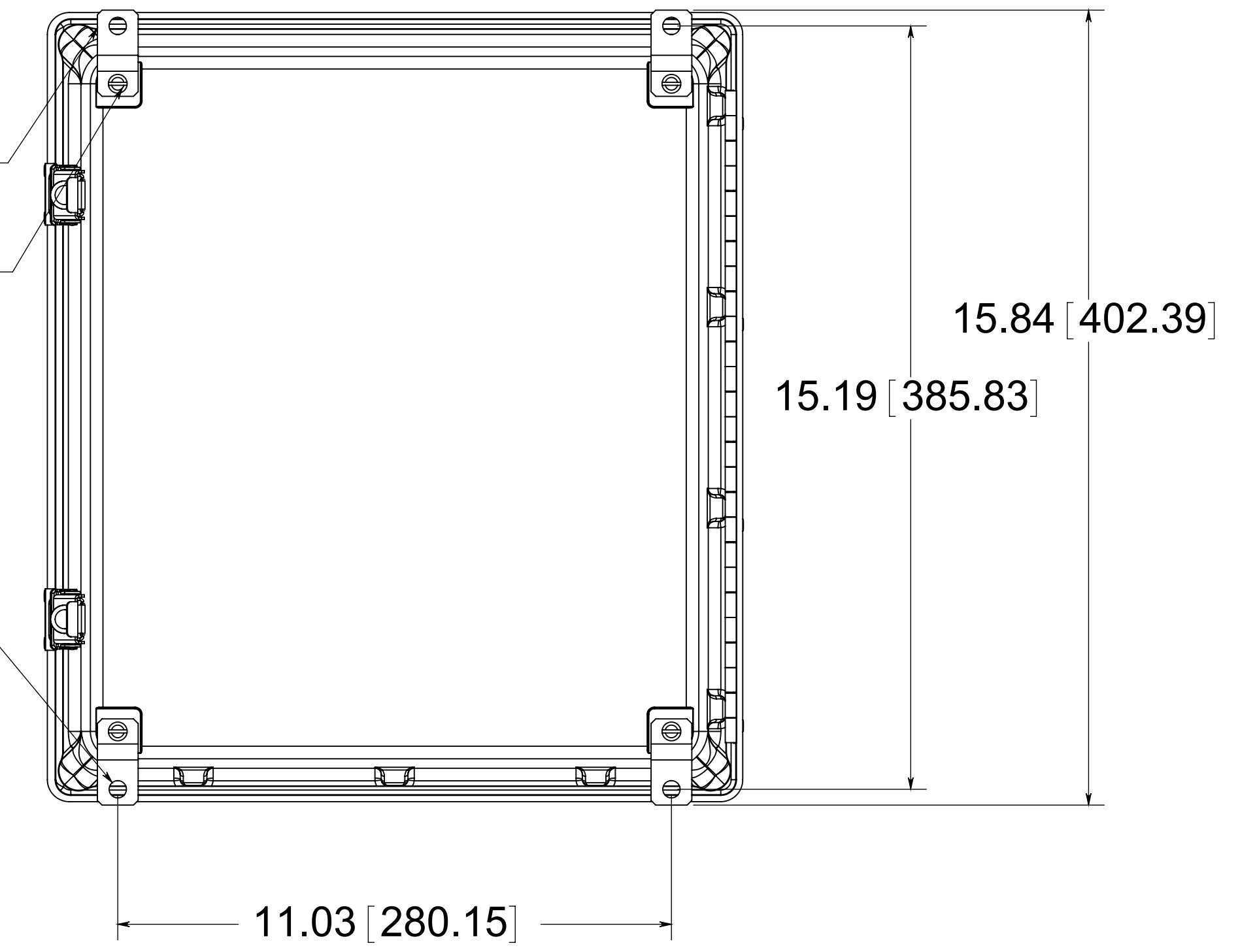

FRONT VIEW WITH COVER REMOVED AND BACK PANEL SHOWN

BACK VIEW

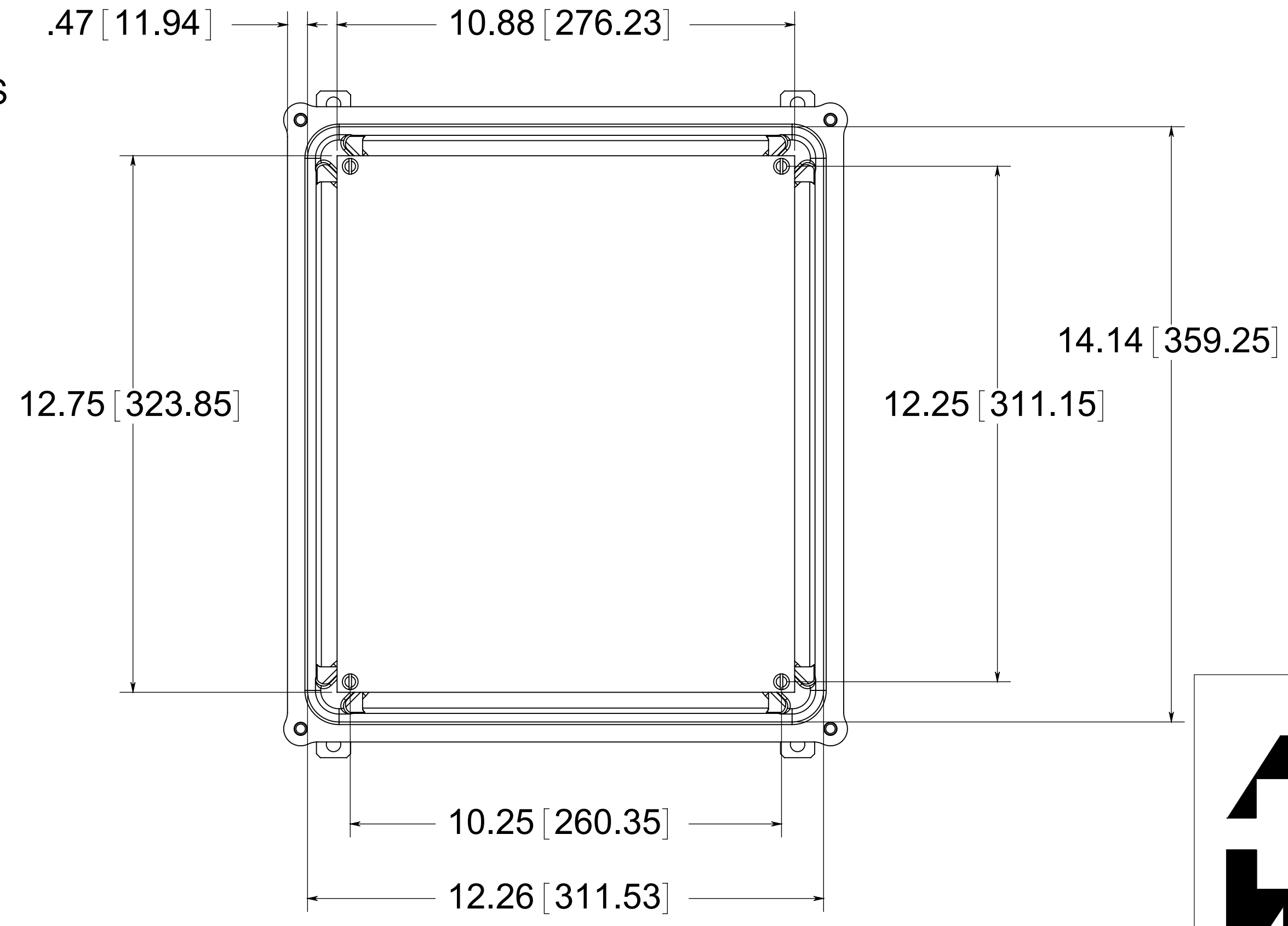
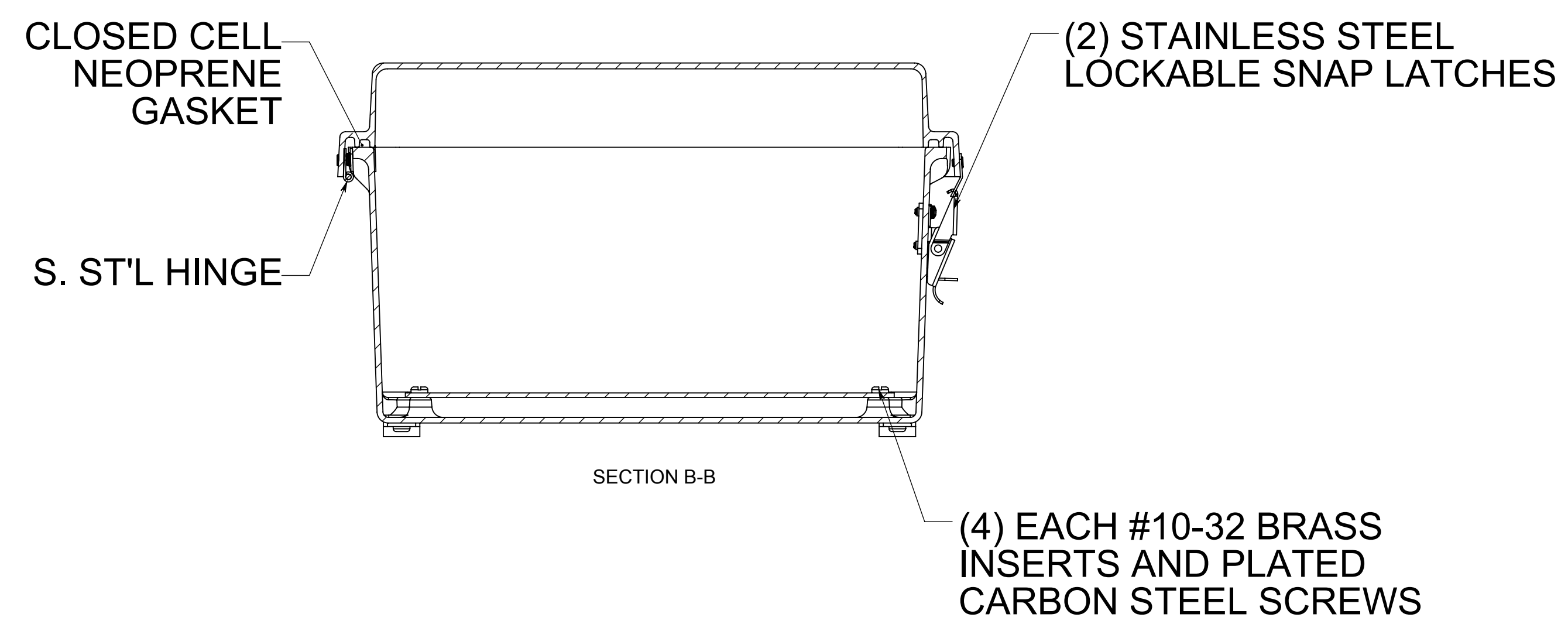

MATERIAL:  
 BOX- COMPRESSION MOLDED FIBERGLASS REINFORCED POLYESTER  
 COVER- COMPRESSION MOLDED FIBERGLASS REINFORCED POLYESTER  
 WINDOW- POLYCARBONATE

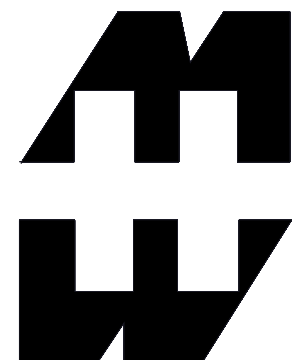

PART No. PJ1426RL  
 for more information visit [www.hammfg.com](http://www.hammfg.com)  
 Data subject to change without notice  
 Drawing Not to Scale