 **PART No. 1422N4SSF24FQT**  
for more information visit  
[www.hamig.com](http://www.hamig.com)  
Data subject to change without notice  
Isometric drawing Not to Scale

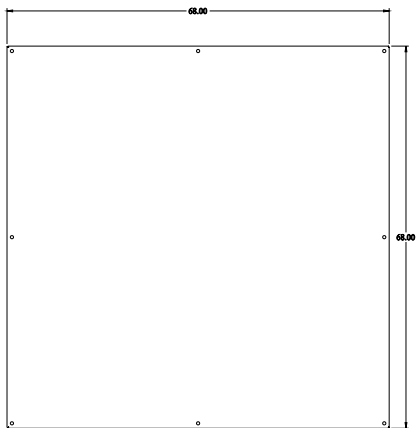

**INNER PANEL**

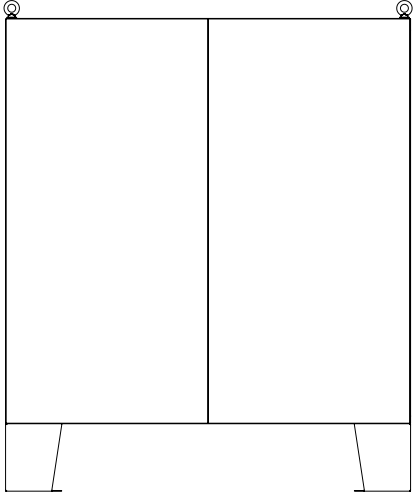

**BACK VIEW**

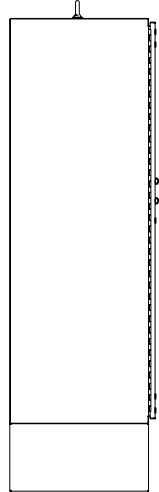

**SIDE VIEW**

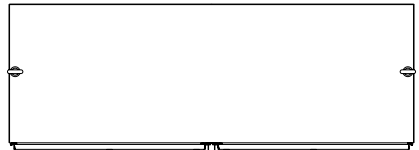

**TOP VIEW**

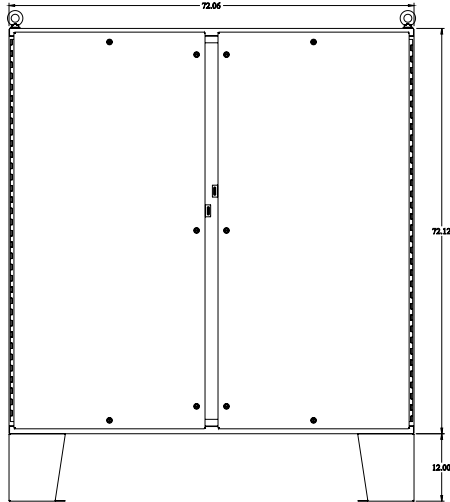

**FRONT VIEW**



**BOTTOM VIEW**

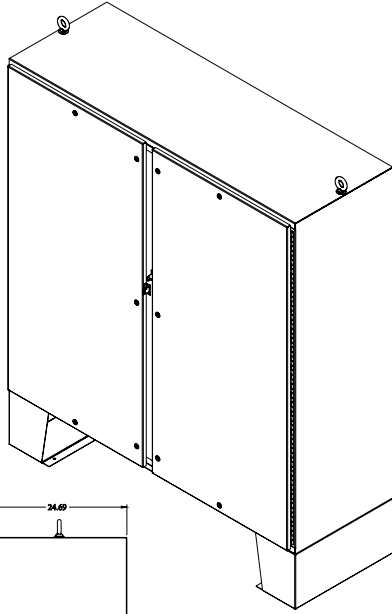

**ISOMETRIC VIEW**

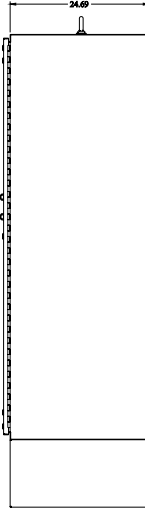

**SIDE VIEW**