 **PART No. 1422N4S16F24FQT**
for more information visit
www.hamig.com
Data subject to change without notice
Isometric drawing Not to Scale

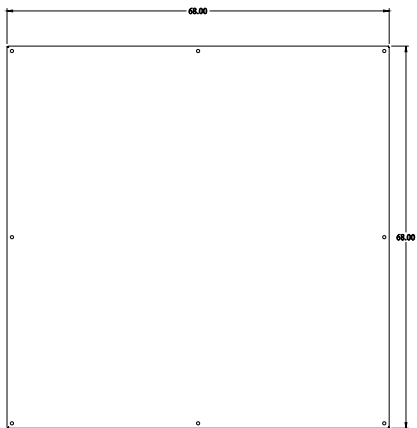

INNER PANEL

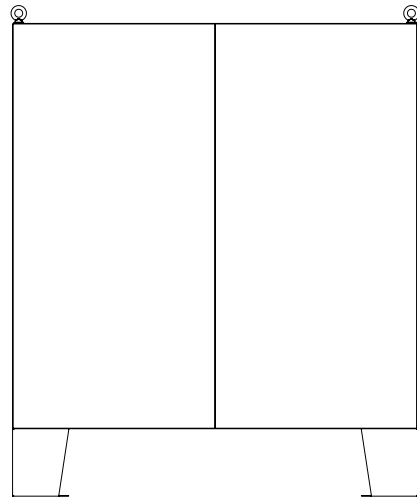

BACK VIEW

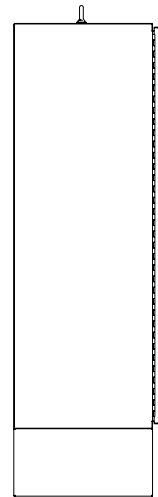

SIDE VIEW



TOP VIEW

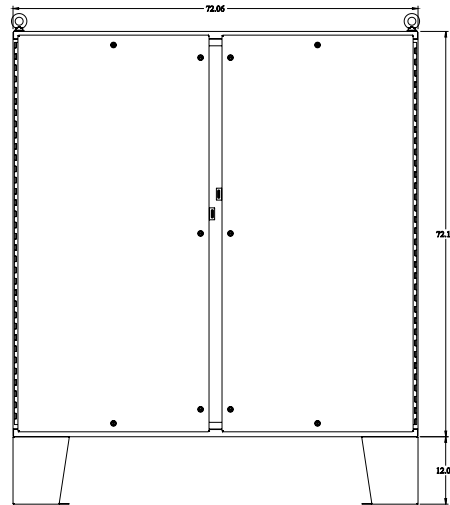

FRONT VIEW

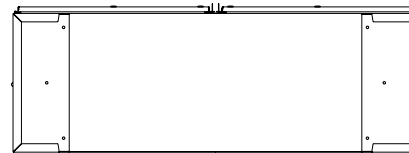

BOTTOM VIEW

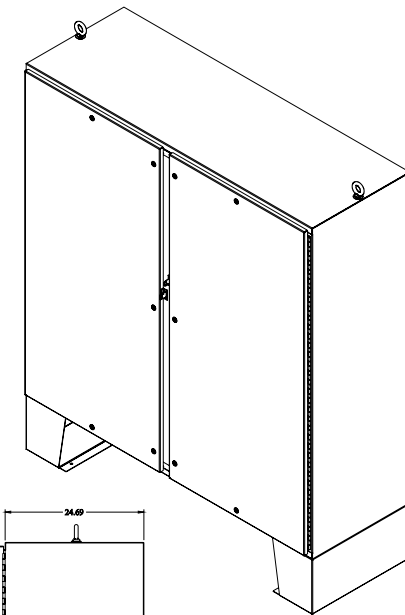

ISOMETRIC VIEW

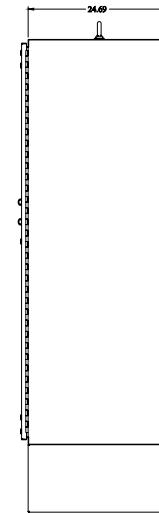

SIDE VIEW