

**PART No. 1422N4S16B12FQT**  
 for more information visit  
[www.hammfg.com](http://www.hammfg.com)  
 Data subject to change without notice  
 Isometric drawing Not to Scale

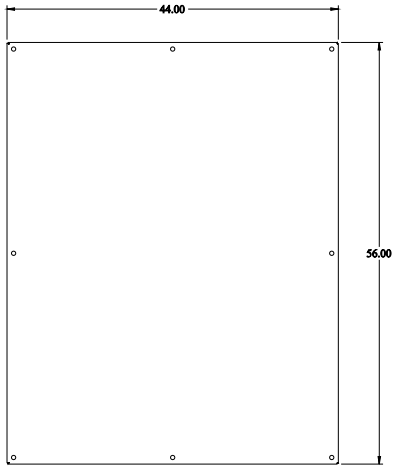

**INNER PANEL**

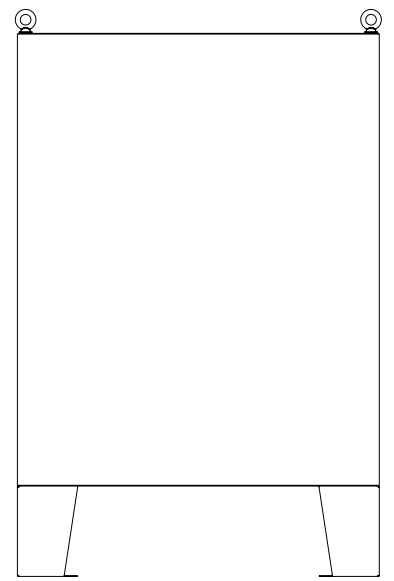
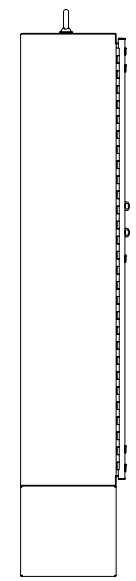

**BACK VIEW**



**SIDE VIEW**

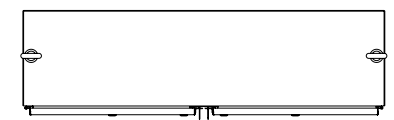

**TOP VIEW**

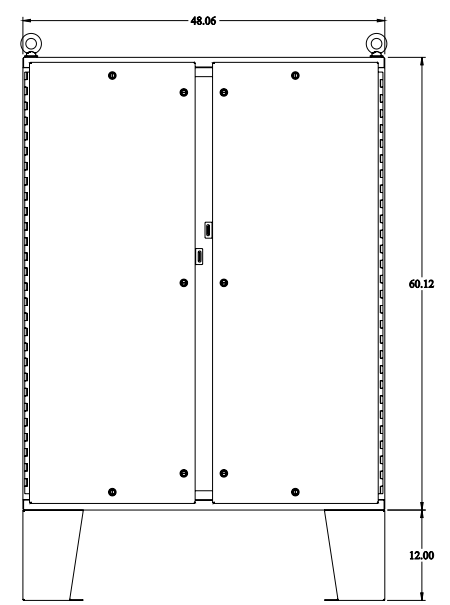

**FRONT VIEW**

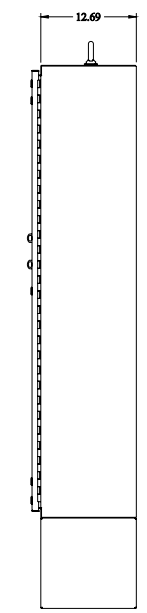

**SIDE VIEW**

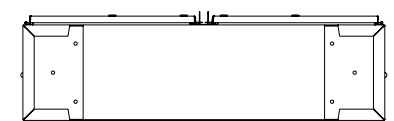

**BOTTOM VIEW**

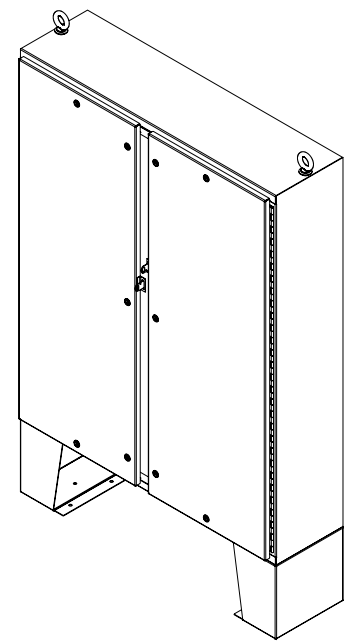

**ISOMETRIC VIEW**