

PART No. CST273

Data subject to change without notice

Isometric drawing Not to Scale

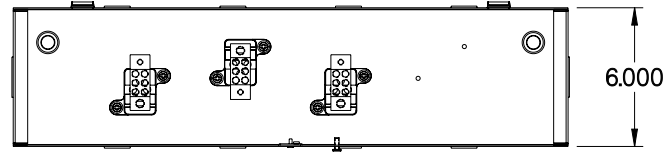

TOP VIEW - COVER REMOVED

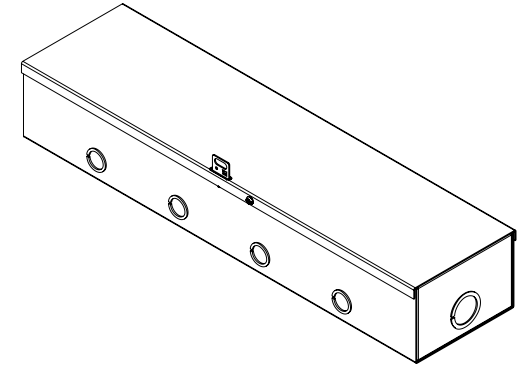

ISOMETRIC VIEW

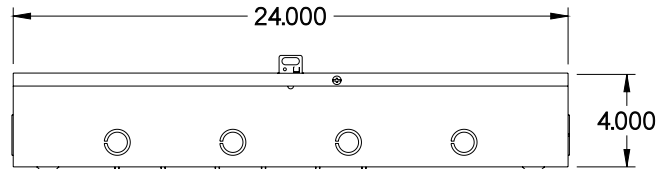

FRONT VIEW

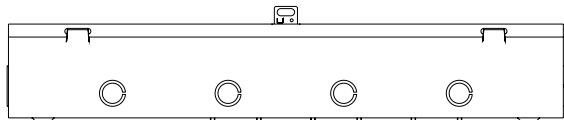

BACK VIEW

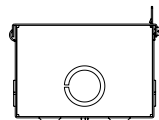

LEFT SIDE VIEW

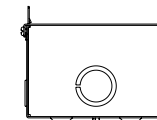

RIGHT SIDE VIEW

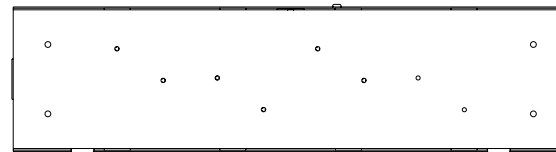

BOTTOM VIEW