

**PART No. CS18124**

Data subject to change without notice

Isometric drawing Not to Scale

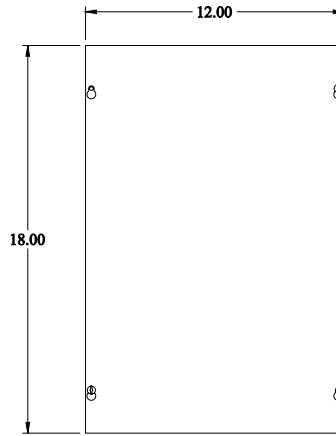

**TOP VIEW**

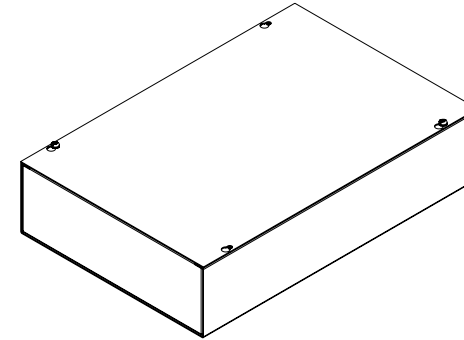

**ISOMETRIC VIEW**



**SIDE VIEW**



**FRONT VIEW**



**SIDE VIEW**

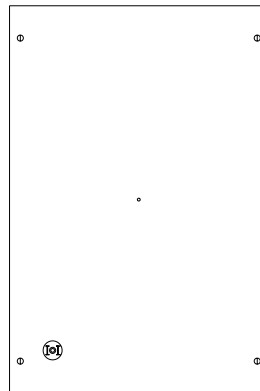

**BOTTOM VIEW**