

PART No. CS1086

Data subject to change without notice

Isometric drawing Not to Scale

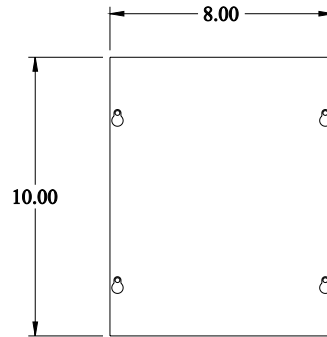

TOP VIEW

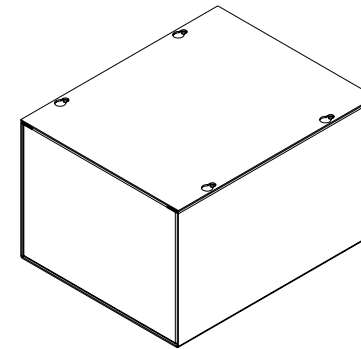

ISOMETRIC VIEW



SIDE VIEW

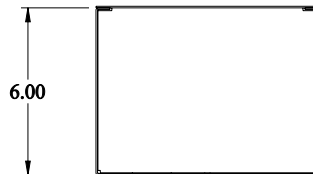

FRONT VIEW



SIDE VIEW

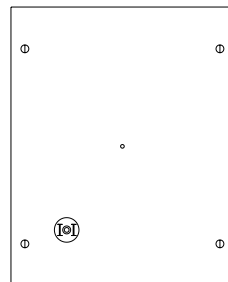

BOTTOM VIEW