

PART No. 1420G9
 Data subject to change without notice
 Isometric drawing Not to Scale

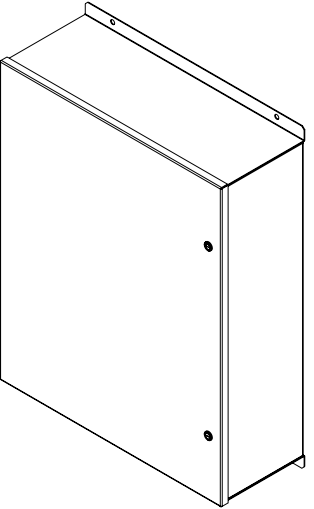

TOP VIEW



ISOMETRIC VIEW

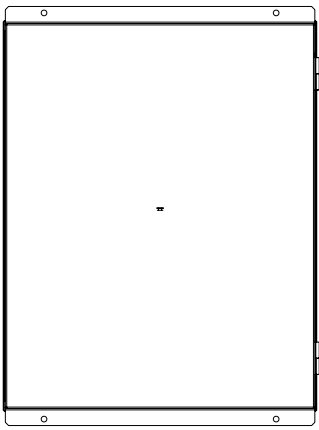

BACK VIEW

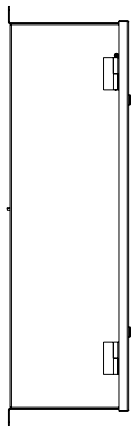

LEFT SIDE VIEW

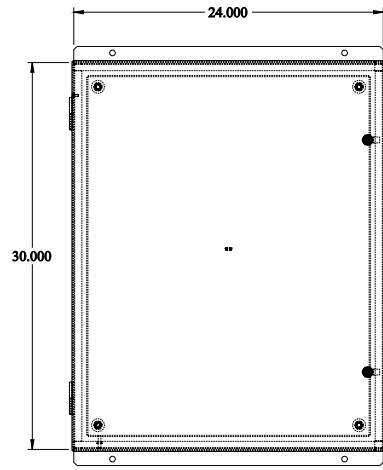

FRONT VIEW

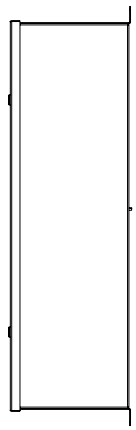

RIGHT SIDE VIEW

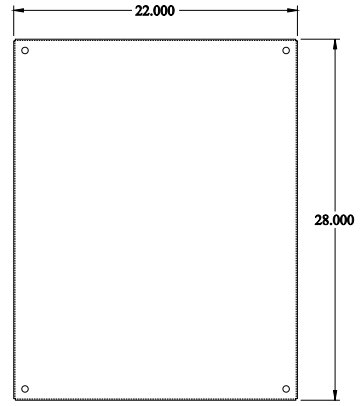

INNER PANEL

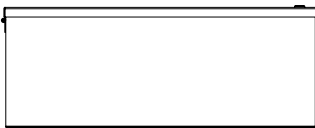

BOTTOM VIEW